

Soybean Production Handbook



Contents

Growth and Development	1
<i>Ignacio A. Ciampitti, Crop Production and Cropping Systems Specialist</i>	
Variety Selection	7
<i>William T. Schapaugh, Soybean Breeder</i>	
Seedbed Preparation and Planting Practices	11
<i>Doug Shoup, Southeast Area Agronomist</i>	
<i>Stu Duncan, Northeast Area Agronomist</i>	
<i>Ignacio A. Ciampitti, Crop Production and Cropping Systems Specialist</i>	
Fertilization	14
<i>Dorivar Ruiz Diaz, Soil Fertility and Nutrient Management Specialist</i>	
Weed Management	16
<i>Dallas Peterson, Weed Management Specialist</i>	
Irrigation	19
<i>Danny H. Rogers, Irrigation Engineer</i>	
Soybean Insects	24
<i>Jeff Whitworth, Entomologist</i>	
<i>Holly Schwarting, Entomology Research Associate</i>	
Soybean Diseases	28
<i>Doug Jardine, Extension Plant Pathologist</i>	
Drying and Storage	33
<i>Joe Harner, Agricultural Engineer</i>	
Profit Prospects	35
<i>Mykel Taylor, Agricultural Economist</i>	
Domestic and International Soybean Marketing	38
<i>Daniel M. O'Brien, Extension Agricultural Economist</i>	
<i>Jay O'Neil, Agricultural Economist, International Grains Program</i>	
Harvesting Soybeans	45
<i>Ajay Sharda, Agricultural Engineer</i>	
<i>Lucas Haag, Northwest Area Agronomist</i>	

Growth and Development

Yield formation for soybeans starts with the planting of the seed in the ground and ends when the grain is harvested. Soybean yield potential depends not only on seed selection, but also on the soybean's genetics and the environmental characteristics in which the plant was grown during development until harvest.

Understanding how a soybean plant grows, develops, and produces grain is essential for understanding the factors that affect plant growth (biomass accumulation) and maximize final yield production.

Soybean seed and its composition is the first component discussed in this chapter. The seed (Figure 1) is a living organism that remains dormant until conditions for germination are achieved. The most important seed components are: testa (seed coat); cotyledons (first leaves to emerge); hypocotyl (first stem of the plant after germination, this tissue is between the cotyledons and radicle); epicotyl (section of the small plant that presents the stem); unifoliolate leaves (the two primary leaves); and the apical meristem.

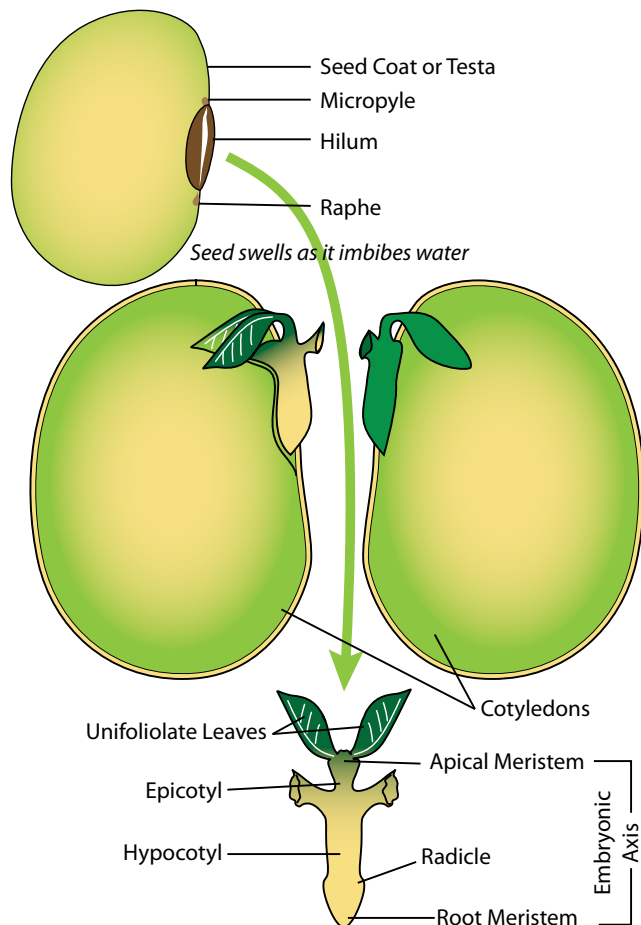

Figure 1. The primary parts of a soybean seed.

Soybeans are planted in soil with an adequate moisture level and warm temperatures (mid-50 degrees Fahrenheit or higher) to allow rapid germination and emergence. Rapid germination occurs when soil temperatures are above 65 degrees Fahrenheit.

Planting dates have shifted in the last 34 years to earlier dates at a rate of 0.5 day per year (Figure 2). The change in planting date may be attributable to changes in: genetics (e.g., improved germination and cold tolerance of modern soybean varieties); environmental conditions (e.g., warmer temperatures in spring); and management practices (e.g., tillage system, rotation, fertility, inoculation, and machinery).

Optimum planting depth is around 1 to 2 inches, depending on the soil temperature and moisture. For early planting dates, as placement depth increases, the emergence period is extended, primarily related to the soil temperature. For late planting dates, soil moisture plays a critical role in determining the time until emergence. Shallow planting (less than 1 inch) without adequate moisture is not recommended. Placing the seed into moist soil is the best strategy when planting late (Figure 3).

Soil conditions will affect the time taken to achieve successful germination and emergence. Soil compaction or crusting produces a delay in soybean emergence, slowing the plant's emergence and/or the root's proliferation in the soil. Flooded soils have lowered oxygen levels, an obstacle for seed respiration and growth.

During germination, a soybean absorbs an equivalent of 50 percent of its seed weight. As the soil temperature approaches an optimum for growth, the first organ to emerge from the seed is the radicle or primary root. This

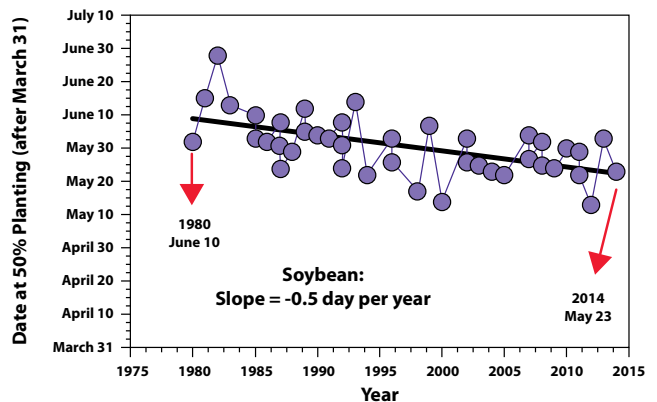

Figure 2. Planting date 50 percent (after March 31) for Kansas. Historical planting 50 percent date evolution from 1980 to 2014 (USDA, *Kansas Crop Progress and Condition*).

organ quickly develops into the primary seedling root. The elongation of the hypocotyl (stem) follows this process, which pulls the cotyledons (seed leaves) above the ground. The hook-shaped hypocotyl straightens out soon after emergence. This type of emergence is known as “epigeal,” referring to the position of the cotyledon after the seedling emerges. Planting depth influences the length of the hypocotyl (elongation), producing a poor overall emergence as the planting depth increases. This affects the time required from planting until emergence. Emergence can vary from 5 to 21 days depending on soil temperature and moisture.

Stages of Growth

It is important to understand how soybeans grow and develop. Since their vegetative and reproductive growth stages occur for several weeks, many environmental conditions can affect final yield. Too much or too little moisture at specific stages of growth can affect performance. Even the type of soybeans, i.e. determinate or indeterminate, influences when a plant starts the flowering or pod-filling stage.

When determining the soybean growth stages, consider that your soybean field will be in a specific growth stage only when 50 percent or more of the plants are in the stage evaluated.

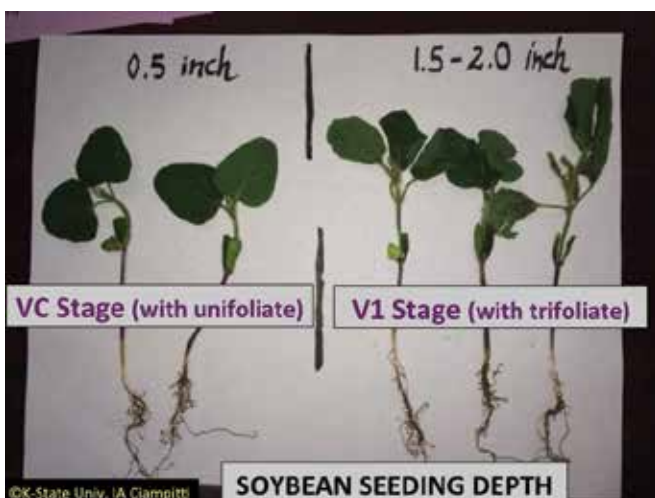
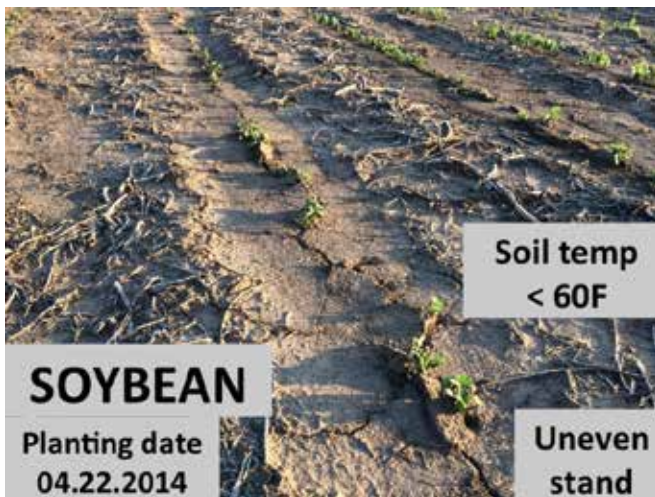
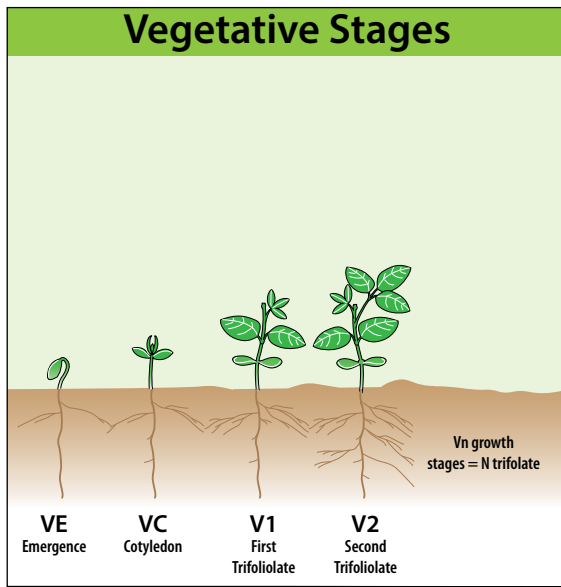

Figure 3. Effect of soil temperature during early season (04/22 planting date) established soybean crop (upper photo) and during late season (lower photo) (06/17 planting date) as compared to diverse seed planting depth (shallow = < 1-inch, adequate = 2-inch). Photos by Ignacio A. Ciampitti, K-State Research and Extension.



Figure 4. Early growth and development for soybean, germination and emergence process (upper photo) and early vegetative stages (lower photo). Photos by Kevin Donnelly, Kansas State University.



Vegetative Stages

Emergence (VE)

During germination and emergence, the cotyledon pokes through the soil and primary and lateral root growth begins. Functional root hairs develop shortly after planting. Root hairs are essential to nutrient uptake and water absorption when the plant is at this early stage.

Management Practices: Scout for proper emergence; check final stand and uniformity. Optimum seed placement varies from 1 to 2 inches deep. Deeper planting depth (greater than 2 inches) and lower soil temperatures jeopardize final emergence. If the stand is poor, replanting may be needed.

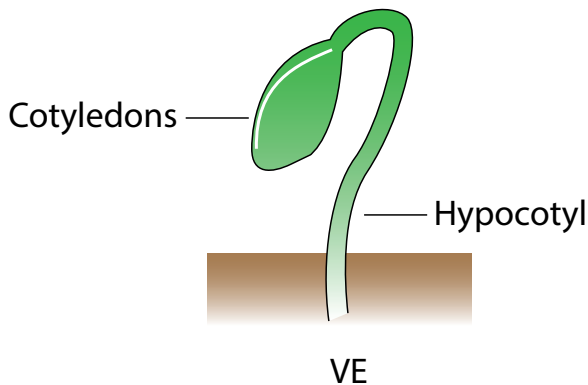

Cotyledon (VC)

Unifoliolate leaves expand (leaf edges are not touching). The cotyledons are the main nutrient reservoir for the young soybean plants (7 to 10 days old). Damaged cotyledons can lower yields.

Management Practices: Scout for proper emergence. Weed control is important before and after soybeans emerge. If stand is poor, replanting may be needed.

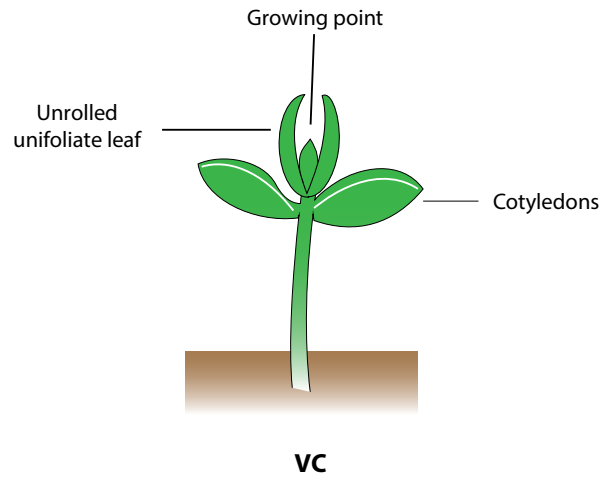

First trifoliolate (V1)

Trifoliolate leaf unrolls (fully developed leaves at the unifoliolate nodes). The plant becomes self-sustaining as newly developed leaves carry out photosynthesis. From this point onward, new nodes will appear every 3 to 5 days until V5 stage (five-node stage), and then every 2 to 3 days until the last vegetative node.

Management Practices: Scout for early-season weeds, insects, and diseases.

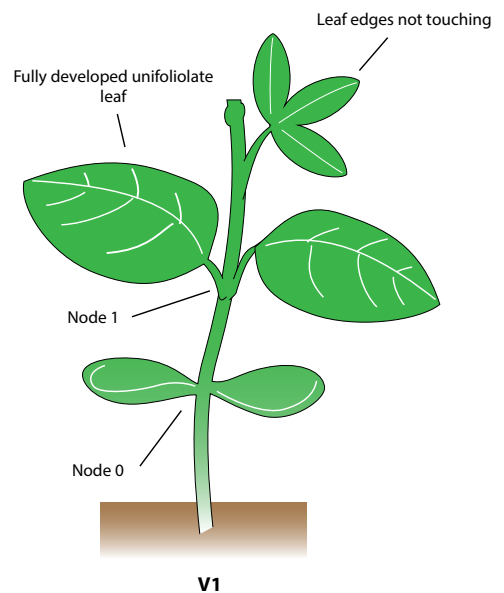

Second trifoliolate (V2)

Two trifoliolates unroll (fully developed trifoliolate leaves at nodes above the unifoliolate node.). Check for proper inoculation. Nodulation has been established on the roots at this stage and nitrogen fixation continues until late reproductive stages. Effective nodulation results in higher yields and more protein when compared with a non-nodulated soybean plant.

Management Practices: Scout for early-season weeds, insects and diseases. Apply postemergence herbicides if needed. If nodulation has been established effectively, nitrogen fertilization is not recommended, and, if applied in large quantities, it will inhibit nitrogen fixation activity.

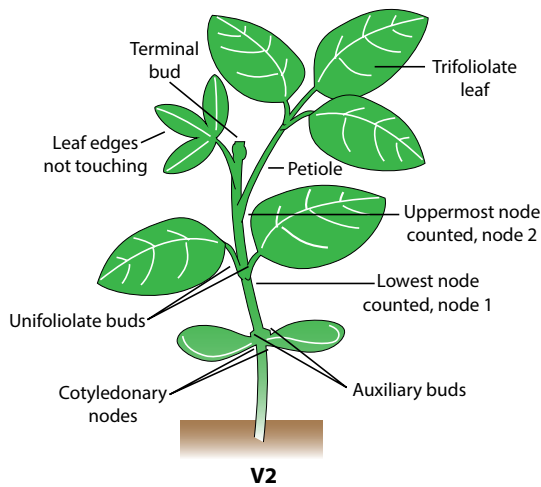

Stages V3 through V6

The third trifoliolate (V3) stage takes place when three trifoliolates are unrolled. In case of damage to the growing point, axillary buds permit the plants to compensate yield or final productivity.

The unrolling of six trifoliolates indicates the V6 stage. The root system continues to grow, even expanding across 30-inch row spacing.

The V growth stages continue as long as the plant continues to produce trifoliolates. Determinate soybean plants complete most of their vegetative growth when flowering begins. Indeterminate plants produced trifoliolates until the beginning of seed formation stage (late reproductive period).

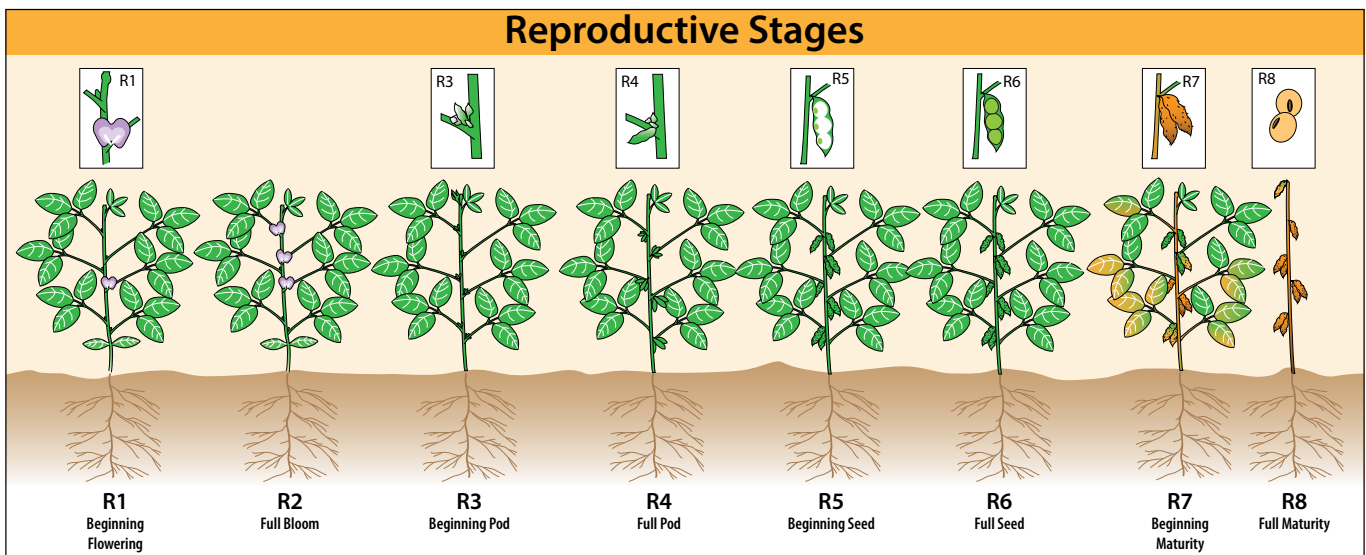

Reproductive Stages

Beginning flowering (R1)

Plant has one flower open at any node on the main stem. Indeterminate plants start flowering at the bottom and flower upward. Determinate plants start flowering at one of the top four nodes and flower downward.

Management Practices: Scout for insects and diseases. Spray foliar insecticide or fungicide, if needed.

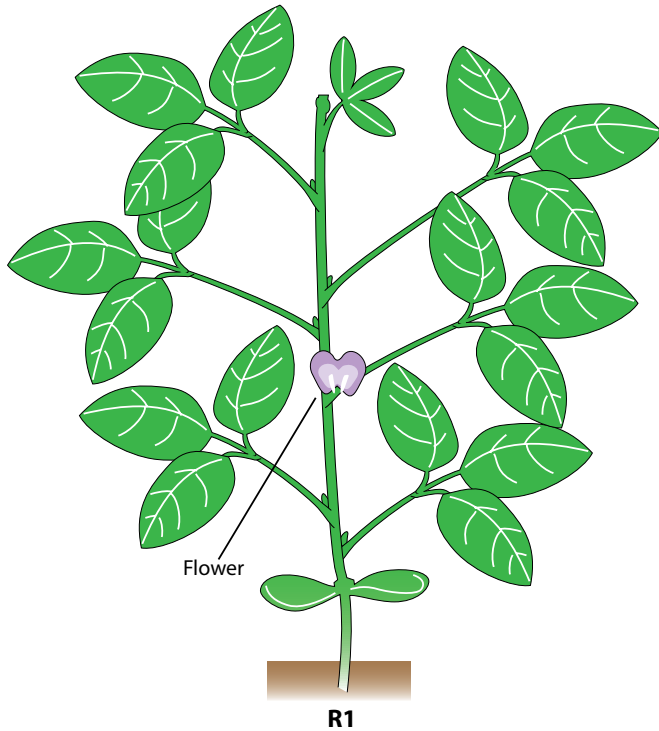

Full bloom (R2)

Soybean plant has one open flower on one of the two uppermost nodes on the main stem with a fully developed leaf.

Management Practices: Scout for insects and diseases. Spray foliar insecticide or fungicide, if needed.

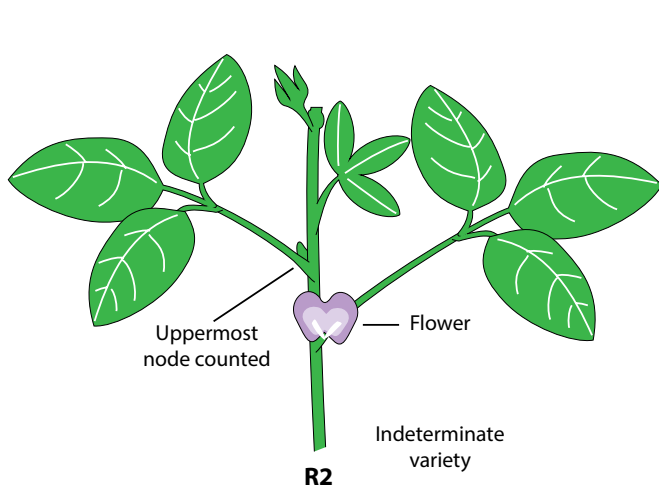

Beginning pod (R3)

Pods are $\frac{3}{16}$ inch (5 mm) long in one of the four uppermost nodes on main stem with a fully developed leaf.

Management Practices: Scout for insects and diseases. Spray foliar insecticide or fungicide, if needed. Identify water stress, which affects pod formation. If it is a common practice, irrigation is critical at this stage. Late-season hail damage to the leaf area at this stage severely affects final yields.

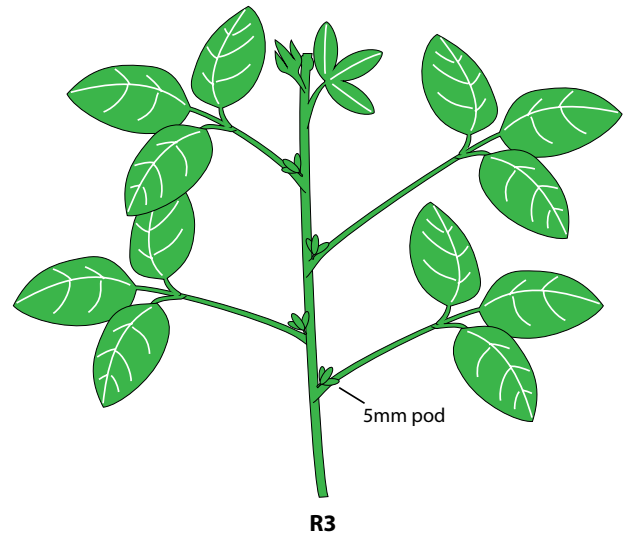

Full pod (R4)

Pods are $\frac{3}{4}$ inch (2 cm) long in one of the four uppermost nodes on main stem with a fully developed leaf. Almost 50 percent of nitrogen uptake occurs around this stage. When determining yield, stage R4 marks the beginning of the most crucial period of plant development.

Management Practices: Scout for insects and diseases. Late-season diseases can lower yields. Irrigation is also critical at this stage. Peak water use can reach 2.5 to 3 inches per week. Spray foliar insecticide or fungicide, if needed.

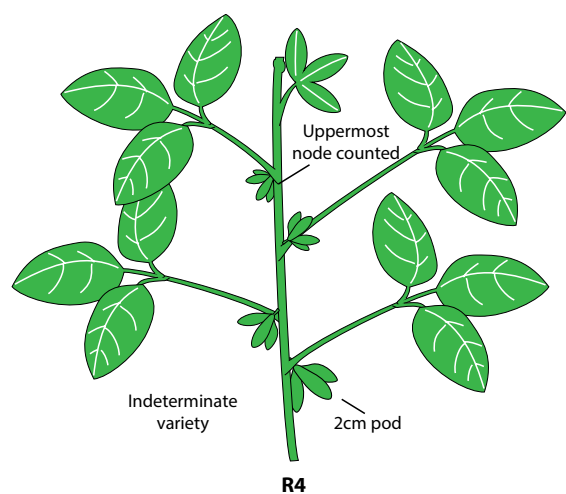

Beginning seed (R5)

Seed is 1/8 inch long (3 mm) in one of the four uppermost nodes on the main stem. Primary and lateral roots grow strong until R5. After R5, the shallower roots degenerate, but the deeper roots and laterals grow until R6.5.

Management Practices: Scout for insects and diseases. Late-season diseases can severely lower yields. Spray foliar insecticide or fungicide, if needed.

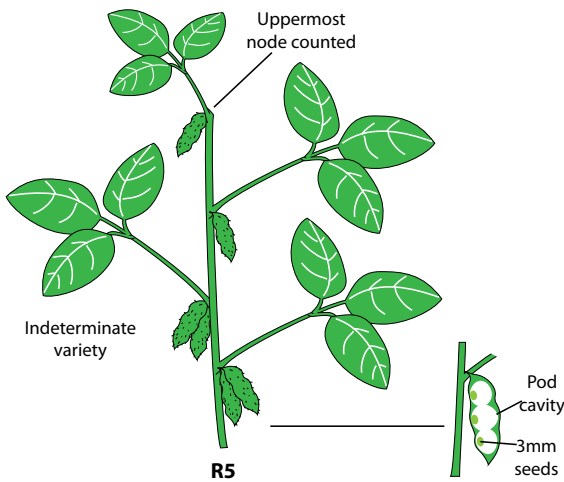

Beginning maturity (R7)

One pod on the main stem has reached mature pod color.

Management Practices: Scout for green stem syndrome and other issues before harvest.

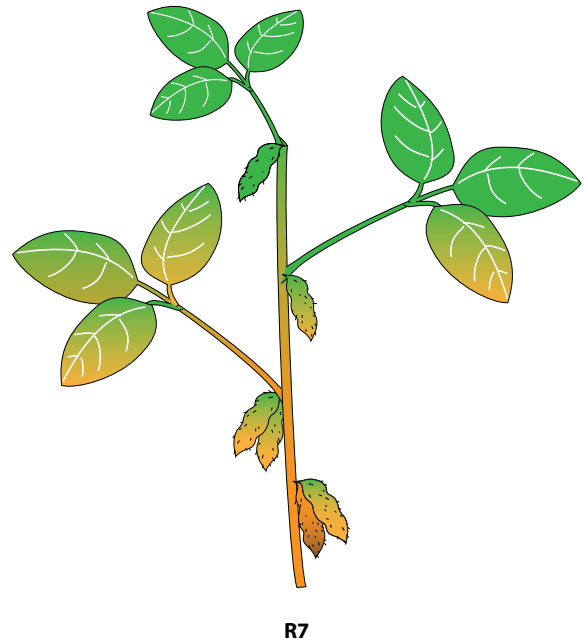

Full seed (R6)

Pods contain a green seed that fills the pod cavity in one of the four uppermost nodes on main stem. Most nutrients have been taken up by the time the plant reaches R6 stage.

Management Practices: Scout for insects and diseases. Late-season diseases can severely affect yields. Spray foliar insecticide or fungicide, if needed. Late-season hail damage to the leaf area could lower yields.

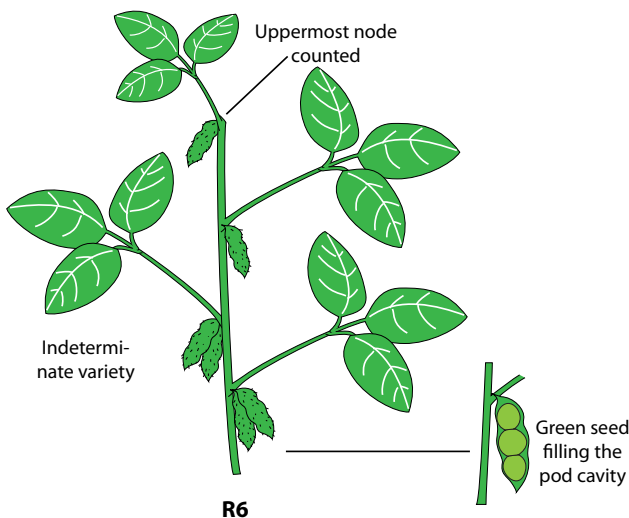

Full maturity (R8)

Approximately 5 to 10 days before harvest, pods should reach full maturity, where 95 percent of pods have reached mature pod color.

Management Practices: Scout for green stem syndrome. If the plant is still green, the best option is to harvest slowly and make sure the harvesting equipment is sharp and in excellent operating condition.

Growth and development stages information adapted from *Soybean Growth and Development*, K-State Research and Extension, United Soybean Board, and Kansas Soybean Commission 2015.

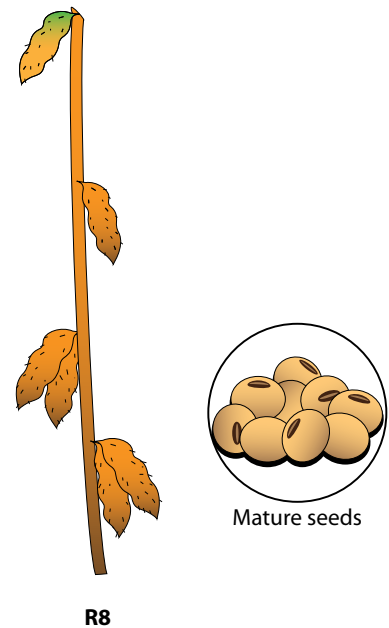

Variety Selection

The choice of variety is a key factor in profitable soybean production. Many characteristics, such as yield, yield stability, maturity, lodging, and disease resistance must be considered when selecting varieties to complement a production area.

Yield and Yield Stability

Harvestable yield is an important characteristic to consider when selecting a soybean variety. It is not unusual for one variety to outyield another variety by 5 to 15 bushels in the same environment. Although improvements in yield do not occur at a rapid pace, a recent evaluation of genetic improvement of soybean varieties in Kansas showed the development of improved varieties represented an increase in yield of about one-third of a bushel per acre per year.

To make the best possible decision regarding yield potential, gather as much variety performance information as possible. Since the performance of any variety varies from year to year and from location to location depending on factors such as weather, management practices, and variety adaptation, consider the performance of a variety across several locations for multiple years. An average across years and locations provides a better estimate of genetic potential and stability than a single site or only a few test sites. However, the selection process is complicated by the many new soybean varieties entering the market each year, while others leave the market. For varieties new to the market, where information across years is limited or unavailable, evaluating performance across locations is especially important.

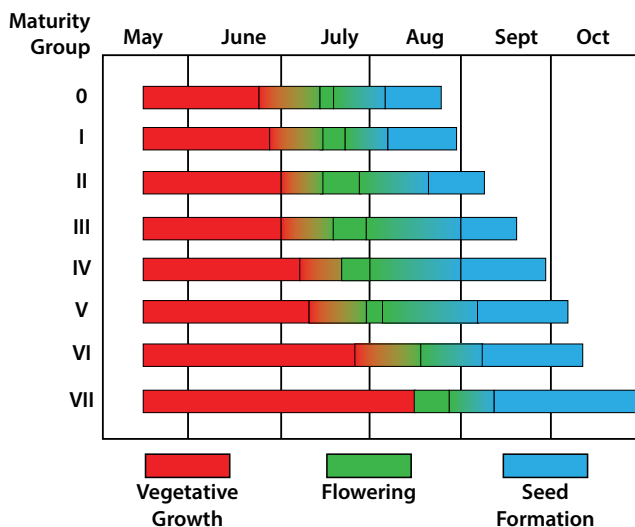

Figure 5. Soybean variety vegetative, flowering, and reproductive growth patterns.

Maturity

Maturity must be closely matched to the production environment and the cropping system. Maturity strongly influences how plant development complements or is affected by weather conditions. Figure 5 provides an overview of the developmental periods of varieties with differing maturities planted in Kansas.

While environmental factors such as heat affect physiological development, soybean plants also are sensitive to day length or photoperiod. Because of this sensitivity, the timing of the transition from vegetative to reproductive or floral development stages and the rate of physiological development are primarily influenced by the photoperiod or day length requirements. Varieties differ in their responses to day length. Some varieties flower under relatively short days (longer nights) while others flower under longer days (shorter nights). Varieties have been classified for photoperiod response based on the ability of the variety to effectively use the length of the growing season in a region.

During the summer, daylight hours increase from the southern to northern United States. This change in photoperiod results in regions of adaptation in the form of horizontal bands running east to west across the United States from the northern states to the Gulf Coast area. Each band extends 100 to 150 miles north to south (Figure 6).

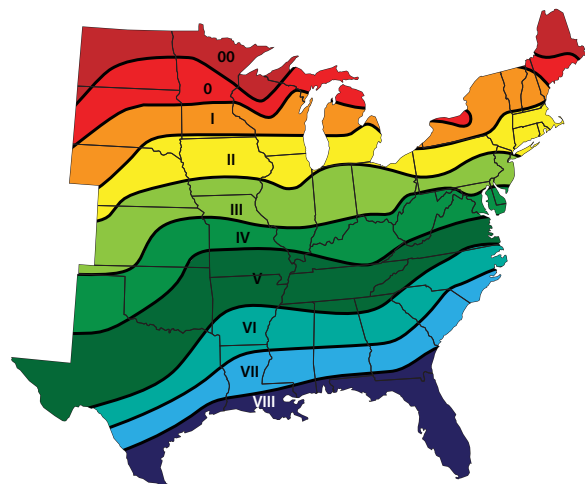

Figure 6. U.S. Soybean maturity group map. Ten maturity groups are depicted in this map from 00 to VIII. The higher the number, the later the maturity and the further south the variety is adapted for full-season use. Lines portrayed in the map are for guiding purposes; there are no clearcut areas where a variety is or is not adapted.

Varieties adapted for full-season production in a particular region are assigned a maturity group number. Varieties in group 00 are adapted to the northernmost regions of North Dakota and Minnesota; those in group VIII are adapted to the southernmost region of Florida and the Gulf Coast states. As the maturity group number increases, the length of the vegetative and reproductive stages of development are extended. A spread of about 10 days in maturity exists for varieties classified in the same maturity group.

Varieties are often moved north or south of their primary area of full-season adaptation to complement a production area. Because of the change in day length, when a variety is moved to the north, flowering will be delayed; when it is moved to the south, flowering will be hastened.

Varieties adapted to Kansas generally are classified in maturity groups III, IV, and V. Varieties from group II tend to mature too early, even in a double-cropping system, except when grown in extreme northern or western Kansas. Group III varieties perform well in northern Kansas and under irrigation throughout the state. Early and mid-group IV varieties can be grown throughout Kansas but perform best in the northeast, east central, and central part of the state. Late IV and group V varieties perform best in southeast Kansas.

Double-cropping is a common practice in Kansas. A soybean crop following wheat is usually planted two to six weeks later than a field under full-season production. Since planting is delayed, often until the end of June or early July, a tendency exists to switch to a shorter season soybean variety to ensure the crop matures before frost.

While planting a later maturing variety increases the likelihood of frost damage, resist switching to a substantially earlier maturing variety. Early maturing varieties planted late in the season usually have limited vegetative development, short stature, and low yield potential. Because of the photoperiod response, there are fewer days to flowering, pod development, and maturity in later plantings than earlier plantings of the same variety.

When planting double-cropped soybeans, the day length has begun or will soon begin to shorten. This reduction in the day length, or increase in the night period, hastens plant development. Planting the same variety at the end of June versus the end of May does not result in a delay in maturity of one month. As a general rule, for every three days delay in planting, maturity is delayed by only one day. Since soybean development is hastened in later plantings, the highest yields in a double-cropped system are often achieved by a variety with the same or only slightly shorter maturity than the variety used in full-season production.

With environmental conditions fluctuating from year to year, growers should consider planting varieties that vary in maturity. Using a range of maturities can lower the risks associated with weather-related yield reductions, such as heat and drought stresses, and facilitates timely harvest and efficient machinery use.

Lodging Resistance

A variety must be able to remain erect throughout the growing season. Lodging during the vegetative or reproductive growth disrupts the light penetration into the plant canopy and may reduce seed yield. Lodging late in the season may reduce harvest efficiency and increase harvest losses.

While varieties differ in their ability to resist lodging, environmental conditions greatly influence the tendency to lodge. Factors such as irrigation and high fertility promote vegetative development and increase lodging. Increasing plant population causes the stems to become taller, more slender, and more prone to lodging. If lodging has been a problem in the past, consider selecting a more lodging-resistant variety in addition to re-evaluating the seeding rate at planting.

Stem Termination Type

Soybean varieties are classified as indeterminate, determinate, or semi-determinate by their morphological growth habit or stem termination type. The indeterminate growth habit is typical of most maturity group IV and earlier soybean varieties grown in Kansas. Maturity group V and later varieties typically possess the determinate growth habit.

Indeterminate varieties continue to grow vegetatively several weeks after flowering, or floral initiation, begins. Plant height can more than double after floral initiation. In contrast, determinate varieties complete most of their vegetative growth before flowering. Plant height can increase slightly in determinate varieties after the onset of flowering, but generally 70 to 80 percent of the mature plant height is achieved before flowering.

At maturity, the indeterminate plant tends to have a relatively even distribution of pods on the main stem with a lower frequency toward the tip of the stem. The determinate varieties tend to have a dense cluster of pods on the terminal raceme at the top of the plant. When comparing varieties of similar maturity, indeterminate varieties are usually taller than determinate ones. The characteristics of a semi-determinate growth habit fall somewhere between the extremes of the indeterminate and determinate types.

While most of the varieties in group IV and earlier possess an indeterminate growth habit, and varieties in groups V and later possess the determinate growth habit,

exceptions to this rule do occur. A few group IV and earlier varieties have been released that are determinate or semi-determinate and a few group V or later maturity indeterminates have been released.

The determinate growth habit in an early-maturity background results in short, compact plants that tend to have excellent lodging resistance. These early-determinate varieties (sometimes referred to as semi-dwarf varieties) are recommended for production systems involving narrow rows, high seeding rates, early plantings, good fertility, and a yield potential in excess of 50 bushels per acre. The determinate growth habit was originally incorporated into varieties to reduce plant height and lodging in environments with long growing seasons. The indeterminate growth habit, which has been incorporated into a few group V and later maturity backgrounds, tends to result in a tall, bushy variety with a long flowering period. These late indeterminate varieties have been recommended for production in stress environments or double-cropped situations where vegetative production may be limited. Regardless of these general recommendations, it is important to select a variety based on its performance in the production area of interest.

Disease Resistance

Widely varying environmental conditions exist in the state during the growing season. These conditions influence the occurrence and severity of diseases attacking soybeans. Although numerous pathogens can affect soybean production, soybean cyst nematode (SCN), charcoal rot, and soybean sudden death syndrome (SDS) are three of the more damaging soybean diseases in Kansas. No single soybean variety provides complete protection against these diseases; however, a number of control measures involving variety selection help minimize losses due to these diseases.

Populations of SCN are genetically diverse, varying in their ability to reproduce on different plant species and on soybean varieties with different resistance genes. Resistant varieties work by limiting the reproduction of SCN on roots, which may result in the reduction of the nematode population in the soil. Important facts to know related to SCN resistance in soybean include: 1) most varieties derive their resistance from PI88788, 2) soybean varieties vary in the level of resistance they exhibit to SCN populations, and 3) most resistant varieties will not prevent the buildup of all populations of SCN.

Based on an ongoing K-State Research and Extension survey of SCN diversity, at least 25 percent of the fields in Kansas infested with SCN possess populations capable of sufficiently reproducing on PI88788 to maintain or increase population density. To properly manage this pathogen, it may be necessary to select a different

soybean variety deriving its resistance from PI88788, or if available, a soybean variety deriving resistance from a different source. Unfortunately, the possibility exists that no currently available soybean variety will adequately reduce the SCN population in a specific field and other management practices will need to be implemented to control the pathogen.

Soybean sudden death syndrome has been increasing in Kansas, especially in fields with high yield potential and those under irrigation. Although no varieties offer complete resistance, varieties differ substantially in resistance or response to SDS. If a field has a history of SDS, seeking out the best source of resistance can produce positive results.

Charcoal rot is an important disease associated with drought stress and high temperatures. Charcoal rot is one of the major soybean diseases without good genetic resistance. Currently, the best recommendation for minimizing losses to charcoal rot is to select planting date, variety maturity, and cropping system and tillage combinations that minimize drought and heat stress experienced by the plants and produce the highest yield. Final yields are a good indication of the levels of drought and heat experienced by the crop during critical periods of development.

Varieties with resistance to other destructive diseases, such as stem canker and *Phytophthora* root rot are available. Additional information on management strategies to control these and other diseases can be found in the soybean disease chapter.

Shattering

Environmental conditions prevalent during harvest in Kansas often test a variety's ability to resist shattering. The developer should have information on shattering resistance from evaluating the shattering response of a variety when left in the field two weeks or longer after maturity or about one week or later after the optimum harvest time.

Iron Chlorosis

In the central and western portions of the state, iron chlorosis is a common problem on highly calcareous soils. Although no soybean varieties are available with complete resistance to iron chlorosis, moderate levels of tolerance do exist that allow for improved soybean production in many problem areas. Often the developer knows how a particular variety responds to conditions favoring the development of iron deficiency chlorosis.

Transgenics

Through the use of genetic engineering, GMO varieties have been developed to carry special traits, such as

resistance to certain herbicides or elevated levels of oleic acid — a mono-unsaturated fatty acid — in the seed. These varieties provide value to growers in addressing specific weed problems or promising health advantages to consumers. New GMO varieties are under development to continue improving production efficiency and end-use quality in soybeans, including new herbicide-resistance options. As these technologies become available, producers will need to evaluate if these varieties add value to and merit integration into their production systems.

Specialty Uses

A majority of soybean acreage is devoted to production of soybean seed for the commodity or crushing market. However, soybean varieties are available that differ in traits and grain characteristics necessary to meet the standards for certain markets, including those for both food and feed. For example, elevated protein content or better protein digestibility may be desirable for improved protein meal. Other markets may require unique oil composition, such as those with high oleic acid, for increased functionality. Physical traits, such as seed size or texture, and visual traits, such as hilum color, may be suited for specific food uses. The introduction of GMO crops has resulted in demand for non-GMO and organic soybean for both commodity and specialty market applications.

Production of soybean varieties capable of meeting the need of specific uses provides the producer the opportunity to capture premiums for grain that possesses these traits. The opportunity for premiums must be weighed against the increased costs that might be associated with the production of a variety that must be maintained through identity-preserved channels, and the producer may need to have a contract to have a market outlet for the soybeans produced.

Conventional and GMO Availability

The majority of soybean varieties available on the market possess GMO traits. That does not mean that conventional varieties are not available for commercial production. With the development of GMO varieties, breeding and genetics programs with the USDA and agricultural experiment stations have continued to develop

improved conventional varieties. In addition to the public breeding effort, some commercial companies continue to focus extensively, or even exclusively, on the development of conventional varieties. While the selection of conventional varieties is not as great as GMO varieties, or the access to seed as widespread, if a producer has interest in producing a conventional variety, available alternatives should result in the identification of an appropriate variety with a suitable seed source.

Many of the conventional varieties are being developed for the commodity market, but others possess traits suitable to target specific end-uses, like those mentioned in the “Specialty Use” section.

Summary

Selecting a variety or a number of varieties for production is one of the many decisions the soybean producer must make throughout the year. The fact that many new soybean varieties enter the market each year complicates the selection process. However, the substantial differences in yield potential among varieties under various conditions make this decision one of the most important. Final selection should be based on a thorough understanding of the production conditions and a careful assessment of varietal characteristics that best complement those conditions. If limited or no data about a new variety are available, the producer must evaluate the risks associated with the lack of information.

To help producers identify varieties best suited to their particular production situation, the Kansas Agricultural Experiment Station conducts performance trials involving more than 100 soybean varieties each year at multiple locations in the state. A number of important traits are evaluated at each location, and additional evaluations are conducted to screen varieties for resistance to diverse SCN populations and SDS resistance. Results of these annual tests are available from the KAES, county Extension offices, or on the web at: www.agronomy.k-state.edu/services/crop-performance-tests/index.html.

Other important sources of information include county test plots and on-farm evaluations. Your seed supplier can provide good information on yielding ability, seed quality, seed size, disease insect resistance, and other traits of importance for their current varieties.

Seedbed Preparation and Planting Practices

To germinate rapidly, soybeans need a soil that is warm (preferably warmer than 60 degrees Fahrenheit at 1 to 2 inches below seeding depth), moist, and well-aerated, which allows good contact between the seed and soil. An ideal seedbed should:

- be free of live weeds,
- provide adequate soil moisture for germination, emergence, and early growth,
- be able to provide wind and water erosion, and
- be suitable for available planting equipment.

Seed Quality

Soybean seeds are extremely fragile and subject to damage by handling, augering, and transporting. Seed moisture influences the extent of damage: drier seed is more easily damaged than seed with higher moisture content. Splits and cracks in seeds can be seen easily, but considerable internal injury can go undetected. The only way to determine seed viability is to run a germination test. Ideally, the germination rate should be 85 percent or greater. If planting into stressful conditions — cool, wet soils, using carry-over seed, or seed with excessive amounts of cracked seed coats — consider an accelerated aging test.

Planting Date

If moisture is available, nonirrigated soybeans produce well across a wide range of planting dates, (Figure 7). However, rainfall distribution and amount during pod-filling determines final yield. Multiple planting dates may be good insurance against inadequate moisture in mid- to late summer during pod and seed fill.

Nonirrigated soybeans may be planted from May 1 until June 20 in most Kansas areas. Mid-May is suggested for northern and northeast Kansas, late May to early June for east central and central Kansas, and early June to early July for southeastern and south central Kansas. Nonirrigated soybeans are seldom grown in western Kansas. If they are, they should be planted in early to mid-May. Earlier planted soybeans, especially when no-tilled or planted into heavy residue, should be treated with a seed-applied fungicide.

Under irrigation, the critical yield-influencing factor of timely precipitation is greatly reduced. Soybeans should be planted when soil temperatures reach at least 60 degrees Fahrenheit in order to make full use of the length of growing season.

Planting Depth

The optimum planting depth for soybean seeds is 1 to 1.5 inches, no more than 2 inches in sandy soils. With early plantings (soil temperatures less than 62 degrees Fahrenheit), slightly shallower seed placement speeds emergence and aids in establishing a more uniform stand. With late plantings in dry soil, slightly deeper placement may be necessary to put the seed in contact with moisture. Certain herbicides necessitate deeper placement to reduce seedling injury. Check herbicide labels for specific planting recommendations.

Soybeans can emerge from plantings deeper than 2 inches, but seedling emergence is slowed or reduced. The seedlings are subjected to more disease organisms, and on heavy soils, poor stands frequently occur because of surface crusting. When soil crusting occurs, the

Figure 7. Soybean planting dates.

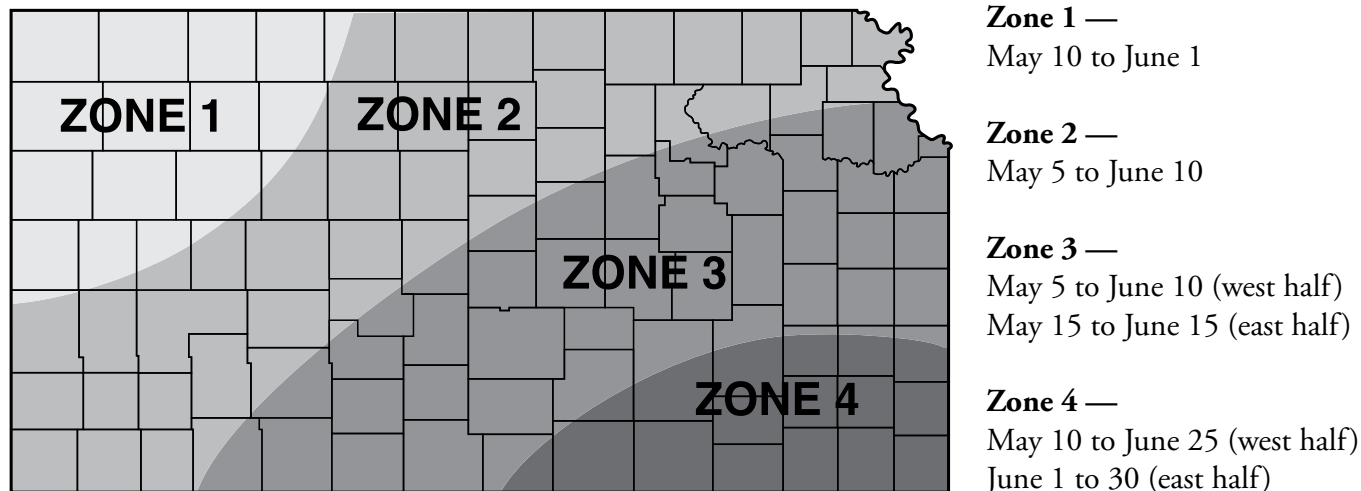

Table 1. Kansas State University soybean row spacing research. Data from studies conducted at Kansas State University by K. Kelly, B. Gordon, B. Haverkamp, and E. Adee.

Location	Year	Research objective	Row spacing		
			30 inch	15 inch	7.5 inch
			Yield (bushels/acre)		
Parsons ^d	2001	No-till, pre and post herbicide	33	36	35
Parsons ^d	2002	No-till, pre and post herbicide	25	24	28
Parsons ^d	2003	No-till, pre and post herbicide	31	35	32
Parsons ^d	2004	No-till, pre and post herbicide	41	44	44
Scandia ⁱ	2004	150,000 plants/acre	76	-	77
Scandia ⁱ	2004	225,000 plants/acre	77	-	73
Scandia ⁱ	2005	150,000 plants/acre	78	-	80
Scandia ⁱ	2005	225,000 plants/acre	80	-	78
Manhattan ^d	2013	High yield soybean	51	52	60
Rossville ⁱ	2013	High yield soybean	37	38	42
Scandia ⁱ	2013	High yield soybean	53	50	54
Ottawa ^d	2013	Planted May 22 3.7 relative maturity	50	49	-
Ottawa ^d	2013	Planted May 29 4.6 relative maturity	40	42	-

i = Irrigated site

d = Dryland/nonirrigated site

Table 2. Seed per linear foot to achieve various final plant stands across four different row widths. Seed drop assumes 80 percent emergence.

Row spacing	Soybean population		
	80,000 plants/acre	110,000 plants/acre	140,000 plants/acre
7.5	1.4	2.0	2.5
10	1.9	2.6	3.3
20	3.8	5.3	6.7
30	5.7	7.9	10.0

hypocotyl of the seedling is not able to break through the crust. If the crust is left undisturbed, the hypocotyl arch or crook breaks or the seedling grows laterally, never emerging. A rotary hoe is useful for breaking a crusted, conventionally tilled soil and allowing the seedlings to emerge, but it may slightly reduce the plant population.

Row Width

Many Kansas producers use a 30-inch row width since it is well-suited for other row crops; however, narrower row soybeans are increasingly popular. Under irrigation, the irrigation method may dictate the row width.

Rows narrower than 30 inches have several advantages. Narrower rows allow the soybean crop to provide an early canopy cover, increase weed suppression, improve light interception, and increase the probability of greater yields. There appears to be a slight yield advantage for narrow-row spacing over wide-row spacing in Kansas (Table 1). However, soybean yields can be variable in the wide range

of environmental conditions in Kansas. Stress reduces or eliminates any gains from narrow row spacing, but in high-yield environments with greater precipitation or irrigation, the increased yield advantage is more consistent.

Plant Population

Soybeans have a great capacity to adjust seeds per pod and pods per plant to compensate for differences in plant stand. As plant population decreases, seeds per pod and pods per plant increase, helping to offset yield losses from lower plant stands. Soybeans in drier environments usually benefit from a lower planting rate, while late plantings require increased seeding rates to compensate for the lack of canopy growth. Recent research in Kansas suggests optimal final plant populations may vary by year and environment but fall in the range of 80,000 to 140,000 plants per acre (Epler and Staggenborg, 2008). High-yielding environments may respond to the higher range of plant populations, while lower yielding environments respond better at the lower range.

Interplant competition increases with increased plant populations, resulting in taller plants with smaller stem diameters, which accentuates lodging problems, and fewer branches, pods, and seeds per plant. Low plant populations or thin stands cause low branching and pods produced lower on the stem, which may increase harvest losses. In addition, plant uniformity within the row becomes increasingly important at low populations, while plant spacing at normal to high populations is generally not a factor in final yield determination.

Seed expense is a significant input in soybean production, so precise calibration of planting equipment can result in significant savings. Producers can use information in Table 2 to determine the seed planted per foot of row when calibrating planters and drills. Seed per foot of row is assuming 80 percent plant emergence in field conditions. Other situations such as upland versus bottomland sites or late plantings may require the planting rate be adjusted up or down. Soybeans in drier environments usually benefit from a lower planting rate, while late plantings require increased seeding rates to compensate for the lack of canopy growth. Because of poor seed-soil contact with some drills, seeding rates may need to be increased by 15 percent compared to a row planter.

Double Cropping

Double cropping is the practice of planting a second crop in the same growing season the first crop was harvested. If double cropping is to be successful, soybeans must be planted immediately after small-grain or canola harvest.

Double cropping is most successful in southeast, east central, and south central Kansas (where irrigated). The length of the remaining growing season and adequate moisture are often the most limiting factors. Substantial yield reductions occur when planting is delayed from mid-June to mid-July, depending on the region of Kansas. Since the remaining growing season and moisture often are limiting, some producers burn the small-grain stubble and plant using a no-till planter or till lightly with a disk or field cultivator and then plant. However, when previous crop residue is not heavy, no-till, double-crop soybeans produce as well as, or better than, other planting methods. No-till, double-crop soybeans save both time and soil moisture. Double-cropped soybeans may experience poor early growth due to excessive small-grain straw. This poor growth and leaf chlorosis can be corrected or avoided with a light application of nitrogen. Labeled plant-back restrictions from herbicide

applications to the preceding small grain or canola crops should be considered before planting double-crop soybeans or selecting herbicide-tolerant seed is recommended.

Conservation Tillage

A number of tillage and planting systems can be used in soybean production. Tillage and planting systems that provide for profitable crop production with minimal soil erosion are often referred to as conservation tillage systems, an umbrella term that includes reduced-till, mulch-till, ecofallow, strip-till, ridge-till, vertical-till, and no-till. The emphasis in conservation tillage is erosion protection; however, savings in water, fuel, labor, and equipment may be additional benefits. Several Kansas State University experiment fields and stations in eastern and north central Kansas have studied the effects of various conservation tillage practices on soybean yields. In most cases, the form of tillage used did not influence yields significantly.

Conservation tillage systems protect the soil surface from the erosive effects of wind, rain, and flowing water either by covering the soil surface with crop residue or by increasing the surface roughness or soil permeability. Water erosion losses for different tillage systems following a 2-inch rainfall are shown in Table 3.

The amount of residue necessary to protect against wind and water erosion depends on several factors such as climatic conditions and patterns, soil erodibility, surface roughness, field length, length and steepness of slope, cropping practices, and other conservation practices. It is generally recommended to leave a 30-percent residue cover on the soil surface after planting where water erosion is the primary concern. Where wind erosion is a problem, 30 percent residue or its equivalent is required on the soil surface during the critical wind erosion period. In situations where conservation tillage alone may not adequately protect the soil from erosion losses, it can be integrated with other conservation practices such as cover crops, terracing, contouring, strip cropping, or wind-breaks to provide the necessary erosion protection.

Table 3. Soil losses for various tillage systems in soybean, corn, and wheat residue.

Tillage System	Corn Residue		Soybean Residue	
	Cover (%)	Soil loss (tons/acre)	Cover (%)	Soil loss (tons/acre)
Plow, disk, disk, plant	4	10.1	2	14.3
Chisel, disk, plant	13	8.3	7	9.6
Disk, disk, plant	--	--	5	14.3
Disk, plant	15	6.6	9	10.6
No-till plant	39	3.2	27	5.0

Wymore silty clay loam, 5 percent slope. Two inches applied water at 2.5 inches per hour. (Data from E.C. Dickey, University of Nebraska-Lincoln)

Fertilization

Fertile soils that produce high yields of other crops also will produce high yields of soybeans. Total nutrient uptake by soybean depends on yield level, which will vary with environmental conditions, variety, soil, and cultural practices. Soybeans take up relatively small amounts of nutrients early in the season, but as they grow and develop, the daily rate of nutrient uptake increases. Soybeans need an adequate supply of nutrients at each developmental stage for optimum growth.

High-yielding soybeans remove substantial nutrients from the soil. This should be taken into account in an overall nutrient management plan (Table 4). Soybeans contain a higher amount of phosphorus and potassium in the grain and remove more phosphorus and potassium from the soil than wheat, corn, or grain sorghum per bushel of grain.

Soil pH and Lime

The nodule bacteria (*Bradyrhizobium japonicum*) associated with soybean roots function best in soils of near-neutral pH, which also favors availability of most plant nutrients.

A soil test can accurately determine the need for lime. Lime recommendations are typically made for pounds of effective calcium carbonate (ECC) to bring the top 6 or 7 inches of soil to pH 6.8. For maximum effectiveness, the lime must be fully incorporated into the soil. Lime is relatively insoluble and may take several months to complete the neutralization reaction.

Lime application rates should be adjusted for tillage methods (incorporation depth). If shallow incorporation is done, the recommended lime rate for the top 6 or 7 inches of soil should be adjusted.

Nitrogen

Under normal conditions, soybeans need no nitrogen fertilizer as the nodule bacteria will fix sufficient nitrogen

Table 4. Nutrient amounts in a 40-bushel-per-acre soybean crop.

Nutrient	Grain	Stover
	Removal lbs/acre	
N	130	44
P ₂ O ₅	29	10
K ₂ O	40	40
S	7.2	7.0

Source: International Plant Nutrition Institute, 2014.

for optimum growth. If soybeans have been grown recently on the land and were well nodulated, re-inoculation is probably not necessary. However, if there is any question about the abundance of nodule-forming bacteria in the soil, or if the land has no history of soybean production, inoculation of the soybeans is recommended. Handling, storage, and use should follow label recommendations to ensure viable bacteria in the inoculant.

Until nodulation occurs, the soybean plant depends on soil nitrogen for growth. Soybeans planted where a large amount of wheat straw has been freshly incorporated into the soil may respond to a starter application of 10 to 20 pounds of nitrogen. The wheat straw causes a temporary tie-up of the soil nitrogen by microorganisms decomposing the straw. On newly leveled land being planted to soybeans for the first time, an application of 30 to 40 pounds of nitrogen per acre may be necessary because of the extremely low available nitrogen in the soil. Recent research has shown that under high-yield conditions (greater than 60 bushels per acre) an application of 20 to 40 pounds of nitrogen at the R-3 stage can contribute to yield increase.

Phosphorus

Phosphorus applications should be based on a soil test. Consistent responses to direct phosphorus fertilization can generally be expected in soils testing very low or low in available phosphorus. Phosphorus recommendations based on soil tests are given in Table 5.

Work with phosphorus placement methods has revealed little difference between banded starter and broadcast application applied at planting time. In a conventional tillage system, a broadcast application should be done before the tillage operation to help with incorporation. However, in a no-till system, broadcast applications show similar response likely due to higher

Table 5. Phosphorus recommendations following a sufficiency approach for a 40-bushel-per-acre soybean crop based on soil tests.

Soil test P (ppm)*	lbs P ₂ O ₅ /acre
0-5	65
5-10	50
10-15	30
15-20	15
20+	0

* soil test P as Melich -3

residue and active roots near the surface, which facilitate plant phosphorus uptake. If a starter fertilizer is used, the material should not be placed in direct contact with the seed. Soybean seeds are easily injured by fertilizer; therefore, no direct seed contact with fertilizer is advised. No difference exists between phosphorus fertilizer sources.

Potassium

Soybean seeds are relatively high in potassium in comparison to corn, wheat, and grain sorghum. Removal of potassium by soybeans is greater than for other crops on a per-bushel basis when only the grain is removed.

As with phosphorus, a soil test is the best indicator of potassium needs. Soils testing very low or low should be fertilized with potassium, either as a banded starter at planting or broadcast. Potassium should not be placed in contact with the soybean seed because of possible salt injury.

Yield increases from potassium are comparable to those with phosphorus under very low and low soil test levels. Potassium recommendations based on soil tests are given in Table 6.

Zinc

Soybeans respond to zinc application in soils testing low in available zinc. Zinc deficiency is most likely to occur in eroded areas that are low in organic matter. Use a soil test to determine the need for zinc.

Table 6. *Potassium recommendations following a sufficiency approach for a 40-bushel-per-acre soybean crop based on soil tests.*

Soil test K (ppm)	lbs K ₂ O/acre
0-40	70
40-80	45
80-120	20
120-130	15
130+	0

Zinc fertilizer can be either banded at planting or broadcast preplant with little difference in response when applied at an adequate rate. Both organic and inorganic zinc sources (chelates and nonchelates) can be used. The chelates are considered more effective than the inorganic sources. Manure applications also are effective in eliminating zinc-deficiency problems.

Iron

Iron deficiency may be encountered on calcareous soil in Kansas. They occur more frequently in the western part of the state. Soil applications of iron fertilizer are typically ineffective due to typically high soil pH and the presence of carbonates. For this reason, chelated iron fertilizer applied to the seed or in-furrow (in contact with the seed) is recommended to correct an iron deficiency.

Other Nutrients

In general, soybeans are unlikely to respond to other nutrients. Calcium and magnesium are relatively abundant in most Kansas soils. Liming acid soils supplies sufficient calcium, so a deficiency of this element would not be expected.

Molybdenum deficiencies are more likely in strongly acidic soils than in neutral or only slightly acidic soils. Liming acidic soils tends to make native molybdenum more available to plants. An adequate liming program should ensure against molybdenum shortages in most soils.

Recent studies with sulfur, boron, copper, and manganese have not shown consistent responses in Kansas. These elements should not be a limiting factor for optimum soybean yields in most soils where soybeans are now being produced.

If a deficiency of one or more of these nutrients is suspected, application should be made to a small test area to see if a response can be obtained. Producers should remember that several of these micronutrients are toxic in relatively small amounts beyond optimum levels.

Weed Management

Weeds cost Kansas soybean producers millions of dollars every year as a result of reduced soybean yields, harvest complications, and costs for control. The most effective way to manage weeds in soybeans is to use an integrated weed management program that includes crop rotation, good crop production practices, cultural weed control practices, and a diversified herbicide program.

A key to planning a weed management program is to be aware of what weed species are present in the field and to have a good understanding of the biology of those weeds. Annual field records of weed species present, relative abundance, and problem spots are helpful in designing an effective management plan.

Early-emerging weeds are most competitive with crops and can be the most difficult to control. Thus, it is important to have a weed-free seedbed at planting. This can be accomplished with tillage in conventional tillage systems or with herbicides in a no-till system. Winter annual weeds generally are not a problem in conventional tillage because they are controlled with spring tillage before planting. However, winter annual weeds such as henbit, field pansy, marestail, and mustards that emerge in the fall or winter can be problematic in no-till systems if not controlled early in the spring. Uncontrolled winter annual weeds use nutrients and moisture, interfere with planting, and are difficult to control at planting time because of their advanced stage of growth.

Fall and Early Spring Burndown Treatments

Fall herbicide treatments from early November through early December or early spring treatments in March and April help control winter annual weeds and create better planting conditions. Herbicide combinations with different modes of action provide the broadest spectrum of control and help prevent the development of herbicide-resistant weeds. Glyphosate, 2,4-D, dicamba, Canopy EX, Autumn Super, Valor XLT, and Authority MTZ are some of the more commonly used fall and early spring burndown treatments in soybeans. Residual herbicides applied in the fall or early spring likely will not provide good control of summer annual weeds emerging after soybean planting, so sequential herbicide treatments will likely be required. Consult herbicide labels for required preplant intervals ahead of soybeans and any guidelines regarding soil texture, soil pH, precipitation requirements, or geographical use restrictions.

Suppressing Weeds with Cover Crops

Cover crops planted in the fall and controlled in a timely manner in the spring also may help suppress weeds. There are many potential cover crop combinations, but to be effective for weed suppression, the cover crop needs to establish quickly and be competitive. Another key component of using cover crops is the ability to terminate them effectively and quickly in the spring to prevent seed production, avoid excessive moisture use, and help create good planting conditions.

Summer Annual Weeds

Summer annual broadleaf and grass weeds are generally the most abundant weeds in soybeans. Some of the more common summer annual broadleaf weeds include waterhemp, Palmer amaranth, velvetleaf, cocklebur, sunflower, and kochia. Common summer annual grasses infesting soybeans include large crabgrass, foxtails, shattercane, fall panicum, longspine sandbur, and barnyardgrass. Summer annual weeds are best managed using a combination of residual herbicides as preplant or preemergence treatments followed by postemergence treatments. The most appropriate herbicide program depends on the weed species present, the cropping system, and the presence of herbicide-resistant weed populations.

Proper Herbicide Use and Performance

Herbicide performance depends on proper application and environmental conditions. Preplant and preemergence residual herbicides require precipitation or irrigation to activate the herbicide and control germinating seedlings. Weeds that germinate and emerge before a residual herbicide is activated likely will not be controlled, but subsequent weed flushes following an activating rainfall may still be controlled. Postemergence herbicides require adequate spray coverage and application to actively growing weeds before they exceed size limits on the label to achieve good results. Application to larger weeds and during periods of environmental stress may result in poor control. Some postemergence herbicides require the addition of adjuvants to optimize performance. Always consult product labels and follow directions regarding application rates, timing, spray adjuvants, application technique, personal protective equipment, and any other restrictions when applying any herbicide.

Herbicide-Resistant Soybean Technologies

Several different herbicide resistant soybean technologies are currently on the market, and others will likely be introduced in the future. Planting herbicide-resistant soybeans provides additional weed-control options, but it also can increase the complexity of management. It is critical to keep accurate records and communicate clearly with your herbicide applicator regarding herbicide-resistant traits within fields to make sure fields are not sprayed with the wrong herbicide. Spray drift and tank contamination on fields with different herbicide-resistant traits are other potential concerns. Regardless of the herbicide-resistant trait, the most effective weed-control programs are integrated approaches with multiple weed control methods and diversified herbicide treatments. Using a more diversified weed management program helps minimize the development of herbicide-resistant weed populations by reducing the reliance on a single herbicide or herbicide site of action.

Managing Specific Weed Problems in Soybeans

Marestail has become a major weed problem in soybeans because of the adoption of no-till and glyphosate-resistant soybeans. Glyphosate-resistant marestail is common throughout Kansas and ALS-resistant marestail also is present. Marestail generally acts as a winter annual, but it also can germinate in the spring and summer and behave like a summer annual. Marestail needs to be controlled before planting soybeans because there are no dependable herbicides to control it after soybeans have emerged. Dicamba, 2,4-D, Canopy EX, Autumn Super, Sharpen, and Valor XLT can all have good activity on marestail when applied in the fall or early spring. Treatments are most effective before marestail starts to bolt; dicamba or 2,4-D are generally recommended in the tank-mix for improved control. Dicamba has been more effective than 2,4-D in research at Kansas State University. Always follow the recommended preplant intervals on the herbicide label to avoid potential crop injury. Liberty herbicide is one of the most effective herbicides to control marestail after it starts to bolt. Liberty can be used as a burndown treatment before emergence of any soybeans or as a postemergence treatment in Liberty Link soybeans. The most effective post-emergence treatment for glyphosate-resistant soybeans is glyphosate plus FirstRate or glyphosate plus Synchrony. However, marestail will not be controlled with this treatment if the population is resistant to both glyphosate and ALS herbicides.

Waterhemp and *Palmer amaranth* are both pigweed species that can be quite competitive with soybeans,

and have developed resistance to glyphosate, and are difficult to control postemergence with other herbicides. Many waterhemp and Palmer amaranth populations are ALS-resistant and some are triazine resistant. The pigweeds are warm-season summer annuals and generally do not start to germinate until late spring, but they can continue to germinate throughout the summer. Preemergence herbicides with good residual pigweed activity are critical to manage pigweeds. Several preplant and preemergence herbicides can provide good pigweed control, including Valor based products, Authority based products, and Prefix. The acetamide herbicides such as Dual Magnum, Outlook, Warrant, and Zidua also can provide good control, but generally are not as effective as the previously mentioned products. In no-till, sequential, or split applications of residual herbicides, early preplant and at planting or early postemergence applications generally provide the most consistent pigweed control. If applied too early in the spring, early preplant herbicides will not persist long enough to control later germinating pigweeds. The only postemergence herbicides that can provide good control of pigweeds are PPO-inhibiting herbicides such as Cobra, Flexstar, Marvel, and Ultra Blazer. All of these products can provide good control when applied to small pigweeds, but control decreases dramatically after pigweeds exceed 3 inches tall, especially for Palmer amaranth. Most of these herbicides also provide some residual pigweed control, so early postemergence applications are critical for successful results. Waterhemp resistance to these herbicides also has been confirmed in Kansas, which further emphasizes the need for a good preemergence herbicide program. Several residual herbicides such as Outlook, Warrant, and Zidua can also be included as a tank-mix in post-emergence herbicide applications to provide additional residual pigweed control later in the season. Liberty Link soybean programs may be a good option in fields with known glyphosate-resistant pigweeds, but still need to be a part of a sequential weed control program with a good preemergence treatment followed by timely applications of Liberty to be effective.

Kochia is an early-germinating summer annual weed that is primarily a problem in western Kansas. Glyphosate- and ALS-resistant kochia are fairly common throughout the western third of the state. Some triazine-resistant kochia is present as well. Kochia begins to germinate in March, and a majority of the kochia has often germinated by the end of April. Consequently, controlling the first flush of kochia before planting soybeans is important. Early spring treatments that include Authority products, metribuzin, Kixor products, or dicamba are probably the best herbicide options for control of the early-emerging kochia. It is critical

to consult the label on these products and follow any restrictions and guidelines regarding soils, precipitation, and preplant intervals. If kochia is glyphosate- and ALS-resistant, effective postemergence herbicide options are limited.

Morningglory are warm season, vining plants that can be difficult to control and create quite a nuisance with soybean harvest. Sequential herbicide programs are the most effective approach to manage morningglory. The most effective preemergence herbicides for morningglory include Authority and Valor-based products. Timely rainfall after application is critical to achieve good control of the first flush of morningglory. Several herbicides, including glyphosate, Liberty, Cobra, Blazer, Flexstar, FirstRate, and Raptor, can provide good control of small, seedling morningglory, but control drops dramatically once morningglory starts to vine.

Velvetleaf, *sunflower*, and *cocklebur* are three large-seeded broadleaf weeds that are competitive with soybeans if not controlled. Fortunately, there are a number of preemergence and postemergence herbicides that provide effective control with timely applications and favorable environmental conditions. Some areas of Kansas have ALS-resistant sunflower and cocklebur, but fortunately, there are no documented cases of glyphosate resistance in these species. The addition of the appropriate rate of ammonium sulfate is critical to achieve good velvetleaf control with glyphosate.

Giant and *common ragweed* generally have not been major weed problems in Kansas soybeans, but they are on the increase in the eastern part of the state.

Glyphosate-resistant ragweed is present in eastern Kansas and is a major problem in states east of Kansas. The ragweeds usually germinate early in the spring and historically were controlled with tillage before planting. Glyphosate-resistant ragweed primarily developed in no-till fields where only glyphosate was used as the burndown and postemergence herbicide treatment. Including 2,4-D, dicamba, and other herbicides as part of the burndown treatment has been an effective approach to help manage glyphosate-resistant ragweed in soybeans.

Annual grasses such as *large crabgrass*, *foxtails*, *fall panicum*, *barnyardgrass*, and *longspine sandbur* are common in many fields throughout Kansas. Preemergence products containing acetamide herbicides such as Dual, Intrro, Outlook, Warrant, and Zidua can provide good annual grass control along with helping control pigweeds. Several herbicides can provide good postemergence grass control, including glyphosate, Liberty, Assure II, Select, Fusion, Poast Plus and related generic products.

Always consult the label and follow directions concerning herbicide application rates, timing, spray additives, application technique, personal protective equipment, and any other restrictions when using pesticides. For more information on specific herbicide use and weed control ratings, refer to the annual K-State Research and Extension publication titled *Chemical Weed Control in Field Crops, Pastures, Rangeland, and Noncropland* available at local extension offices or at the K-State Research and Extension website.

Irrigation

In 2013, irrigated soybean acreage represented about 12 percent of the approximately 3 million irrigated acres in Kansas and has been relatively stable for more than a decade (Figure 8). Soybeans are a relatively drought-tolerant crop but respond well to irrigation. Total acres of soybeans harvested have ranged from 2.4 to 4.3 million acres with about 10 to 15 percent of those acres under irrigation. In years with low dryland production levels, such as 1984, 1991, 2000, 2002, and 2003, statewide irrigated yields were 2.5 times to more than triple dryland yields (Figure 9). Soybeans should remain a viable irrigated crop option because of their good yield potential, favorable economic returns, and overall value as part of a crop rotation.

Plant Characteristics

Soybeans are a relatively deep-rooted crop. In deep, well-drained soils with no restricting layers, roots can penetrate to a depth of 6 feet. However, as with all crops,

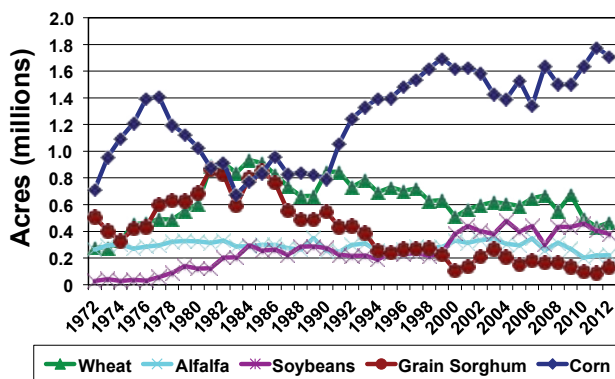

Figure 8. Major irrigated crops of Kansas acreage trend.

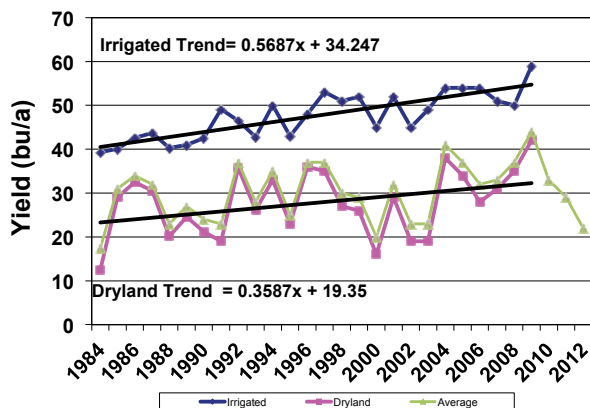

Figure 9. Kansas irrigated and dryland yield trends for soybeans.

most of the roots are concentrated in the upper half of the root zone. Managing a root zone of 3 feet is the general irrigation recommendation.

Soybean crop water use requirements, also known as total evapotranspiration (ET), range from 18 to 26 inches for the entire growing season. Climatic conditions substantially influence water use, and water use is generally higher in the west than in the east (see K-State Research and Extension publication, *Agricultural Crop Water Use*, L934 for more information). A good estimate for the state would be around 22 inches.

Daily water use varies with the stage of growth and weather conditions. The typical peak water use rate is about 0.32 inches per day, which normally occurs near the beginning of the pod fill stage. Reproductive growth stages are described in Chapter 1 and noted relative to the water-use pattern in Figure 10. Water use is low at the germination and seedling stages, peaks at or near the full bloom stage, and declines with maturity. Given the rainfall patterns and typical planting dates for soybeans in Kansas, the most critical time for adequate soil water availability is during the end of the reproductive period when pod fill begins. Soybeans produce many flowers relative to the final number of pods, so losing a few flowers to light water stress earlier in the reproductive cycle is not as critical to final productivity as the same water stress during pod fill.

Net irrigation requirements for soybeans in dry years range from around 14 inches in western Kansas to less than 5 inches in eastern Kansas (Figure 11). Requirements in an average year will be 2 to 4 inches less (Figure 12).

Marias and Bufé (2013) summarized more than 40 research studies on soybean irrigation by stage of

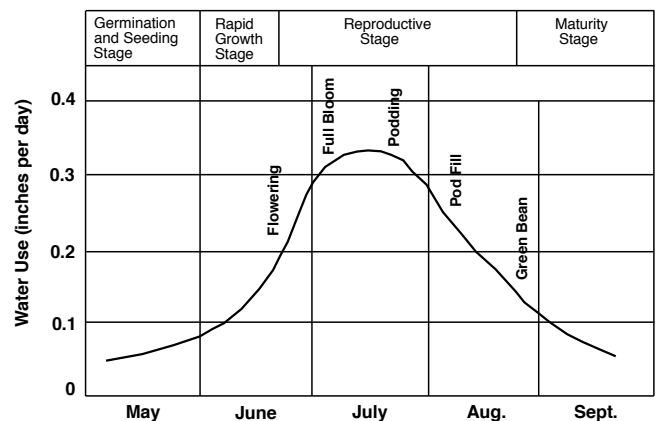

Figure 10. Characteristic growth and water use pattern of soybeans.

growth. The strongest consensus was that irrigation during the vegetative growth stage is needed only if the plants are under severe water stress. Irrigation beginning at flowering was commonly advised, but beginning irrigation at pod formation also was a common recommendation, an indication that the local conditions dictate the best management practice. Another strong consensus was to continue irrigation through pod and seed growth stages, recognizing irrigation or prevention of low soil water levels after maturity is unnecessary.

Various research studies across the Kansas and throughout the High Plains region confirm the general rule that the most beneficial timing for limited irrigation

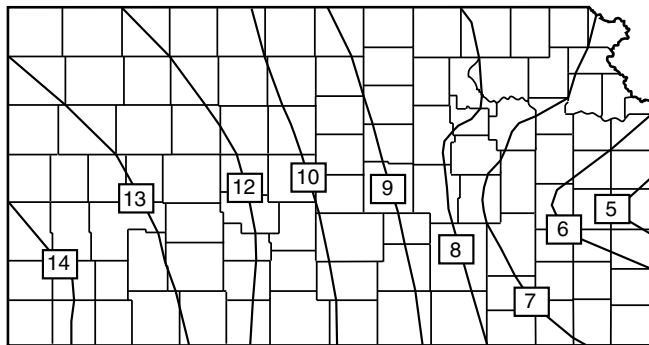

Figure 11. Net irrigation requirements for soybean with an 80 percent chance of rainfall (dry year). Source: NRCS Kansas Irrigation Guide.

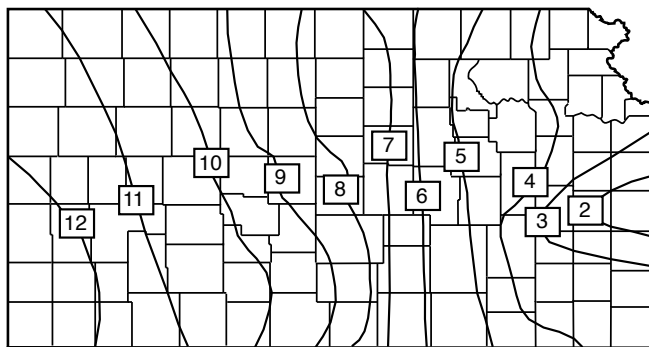

Figure 12. Net irrigation requirements for soybean with an average 50 percent chance of rainfall (average year). Source: NRCS Kansas Irrigation Guide.

Table 7. Irrigation effect on soybean yield. (Scandia Irrigation Experiment Field, Scandia, KS. 1974-1978; 1980; Excessive rain in 1979 prevented application of early bloom treatments.)

Irrigation Treatment	Average Annual Irrigation (inches)	Average Yield (bushels per acre)	Irrigation Water Use Efficiency (bushels per inch)
Early Bloom	4	38.4	9.6
Late Bloom	4	39.2	9.8
Early Bloom and Late Bloom	8	40.8	5.1
30% Soil Depletion	19.1	50.5	2.6
60% Soil Depletion	8.7	50.3	5.8

is during the latter part of the reproductive growth stage. This is generally true because early-season growth and development can be satisfied by typical amounts of rainfall and stored soil water. If full irrigation is possible, the recommended irrigation practice is to use either an ET-based or soil water monitoring based irrigation schedule using a criteria of 50 to 60 percent allowable soil water depletion. This allows maximum use of water from rainfall and reduces lodging problems associated with early wet conditions.

Research results from Scandia illustrate these general guidelines. Table 7 shows a multi-year comparison for stage of growth and soil water depletion scheduling that was conducted on clay loam soils using surface irrigated basins and 4-inch irrigation applications. Irrigating once during the late-bloom stage shows a slight yield advantage as compared to a similar amount of irrigation during the early bloom stage and only a slight increase in yield compared to irrigating both during early and late bloom periods. Irrigation was not applied in 1979 due to early wet conditions.

Scheduling by soil water depletion, which does not limit the total season application amount, shows that although irrigating by 60 percent depletion uses less water, the yields are similar to the 30 percent depletion method. The 30 percent depletion also occasionally increased lodging. The 30 percent depletion treatment had low irrigation-water use efficiency since the soil water levels were kept at high levels, which allowed little opportunity to capture and store rainfall during the growing season.

For the 6-year period, the 60-percent depletion study only applied one additional irrigation as compared to the treatment that applied water at early bloom and late bloom, yet had a much better yield. This indicates scheduling based on crop water demand would be an improved irrigation management practice, even under limited irrigation circumstances.

Soil type, irrigation system type, and irrigation system capacity are some of the influences that determine how various irrigation scheduling management strategies

can be implemented. Although they are important to understanding a crop's physiological response to water, the practices of studies that scheduled irrigation by stage of growth are difficult to implement on a field basis where the irrigation interval exceeds the length of the growth stage. Soil type is also an important consideration as this study was conducted on a high water-holding capacity soil. The management strategy for a low water-holding capacity soil, such as sand, would be different since there is little water storage reserve in sand as compared to clay loams or other high water-holding capacity soils. See K-State Research and Extension publications *Efficient Crop Water Use in Kansas*, MF3066 and *Important Agricultural Soil Properties*, L935 for more information on center pivots and soils.

The benefits of scheduling irrigation using an allowable soil water depletion or crop water budget based approach were again indicated by a 1991 study at Scandia. Growing season rainfall at Scandia in 1991 was 8.3 inches below the 30-year average. Results from a 1991 soybean trial at Scandia (Table 8), indicated a strong yield increase from a single, in-season irrigation as compared to dryland. Yield also increased as the number of irrigations increased; however, the maximum yield of the trial occurred using a 50 percent

depletion criteria, which used less water than the three-application stage of growth treatment. It appears that as more water is applied, scheduling by soil water depletion is recommended to gain maximum benefit. Go to www.bae.ksu.edu/mobileirrigationlab for information on KanSched, an ET based irrigation scheduling program.

A soybean scheduling study conducted at K-State's Northwest Research-Extension Center at Colby used crop-water use or crop ET as the basis. Six levels of irrigation treatments from rain-fed (dryland) to 100 percent replacement of ET were used. Two treatments applied limited irrigation water, irrigating at 75 percent and 50 percent of ET. Two other treatments had two levels of irrigation scheduling criteria, limiting irrigation in the vegetative growth stage to either 75 percent or 50 percent ET, but then irrigating at 100 percent ET after the vegetative growth stage. The yield and irrigation application amount for this study are shown in Table 9. The mean yields followed the trend of more yield with increased net irrigation.

In 1986 and 1987, the yields of the limited irrigation treatments during the vegetative stage were equal to or greater than the full (100 percent ET) irrigation treatment. In 1988, the early season crop ET rates were higher

Table 8. 1991 Irrigation effect on soybean yield (Scandia, KS).

Irrigation Treatment	Irrigation Date*	Yield (bushels per acre)
No irrigation	-	19.4
Full bloom	7/18	41.6
Full bloom and mid pod	7/18, 8/1	46.1
Full bloom and mid pod and mid seed fill	7/18, 8/1, 8/18	51.1
50% soil water depletion	7/18, 8/21	51.6

*Irrigation is approximately 3 inches per event

Table 9. Summary of soybean response to irrigation treatments from the KSU NWREC, Colby, KS. (1986-1988).

	1986		1987		1988		Mean		IWUE* (bu/in.)
	Yield (bu/a)	Net Irr. (inches)	Yield (bu/a)	Net Irr. (inches)	Yield (bu/a)	Net Irr. (inches)	Yield (bu/a)	Net Irr. (inches)	
100% ET	57.7	15.5	49.7	11.1	64.4	12.7	57.3	13.1	2.41
75% Veg/100%	59.7	10.8	48.5	11.4	55.6	12.5	54.6	11.6	2.49
50% Veg/100%	59.5	10.4	51.7	9.9	42.9	10.3	51.4	10.2	2.51
75% ET	56.4	10.2	48.2	7.2	54.3	9.8	53.0	9.1	3.00
50% ET	39.9	3.6	40.3	3.5	32.2	3.2	37.5	3.4	3.41
Rainfed	26.3	---	29.0	---	21.7	---	25.7	---	---
LSD (0.05)**	10.7		5.3		9.9				

*Irrigation Water Use Efficiency

**LSD is least significant difference. If the difference between two treatments is greater than the LSD, then the difference is significant.

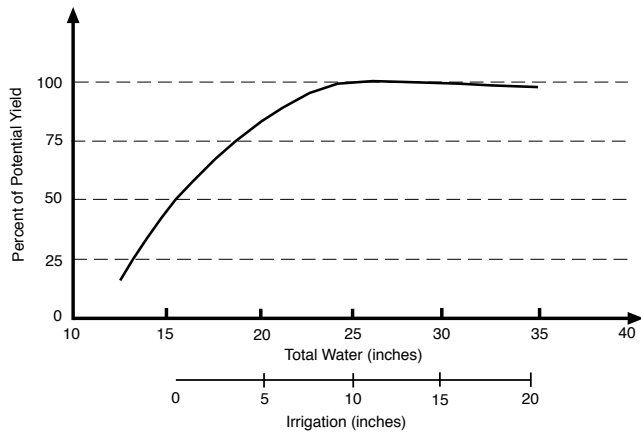

Figure 13. *Soybean yield production function.*

than normal and precipitation was much less than normal resulting in severe vegetative stress that resulted in yield levels that were much lower for the two vegetative stress treatments as compared to the 100 percent treatment. This suggests a vegetative stage irrigation may have been beneficial, which is consistent with the conclusion of the Marias and Bufé (2013) irrigation summary.

Studies at the Northwest Research-Extension Center that used several irrigation scheduling methods and a range of applied irrigation amounts were plotted showing expected yield versus water use (Figure 13). Yield is shown as a percent of test maximum, the value of 100 percent yield might be considered to be the average of the best soybean test performance in the area. Total water represents the water used by the soybeans plus water losses, which for these studies was primarily percolation below the root zone. The irrigation applied is shown on a second horizontal x-axis and represents the amount of irrigation water required to achieve the total water value.

For western Kansas, a total water use of around 24 inches results in near maximum yield potential (Figure 13). Over the long term, applying less water results in lower yields. Applying more water (above 24 inches) does not improve production and may cause inefficient irrigation or loss of natural precipitation. Irrigation amounts of about 11 inches in normal rainfall years would be needed to obtain the maximum yield without wasting irrigation water.

If irrigation water is limited, the irrigator can use Figure 13 as a guide to predict a realistic yield goal for the amount of water available. For example, if only 9 inches of irrigation water can be applied during the growing season in western Kansas due to well-capacity, conservation program, or water-right limitation, a realistic long-term yield goal would be 85 to 90 percent of the yield potential. These types of relationships are somewhat easier to establish for western Kansas

irrigation conditions since irrigation requirements have fewer seasonal variations.

Rainfall and soil water-holding capacity are variables that must be taken into account in any irrigation management program. Monitoring soil water or maintaining a record of crop water use is essential for efficient, high-yielding production. Scheduling irrigation based on plant growth stage or time of year may produce satisfactory results under normal conditions, but it frequently fails to produce the most beneficial results because it does not reflect what is actually happening in the root zone. Experience is a valuable guide, but new situations occur for which past experience offers no guidance. Under such situations, there is no substitute for measurements or estimates of soil water amounts and crop water use rates.

Medium- and Fine-textured Soils

If the potential root zone is near field capacity of available soil water at planting time, irrigation before late bloom or early pod set may not be beneficial. The available soil water in the top 4 feet of soil will be 8 to 12 inches and should be an adequate supply for the plants until the late-bloom stage if rainfall is near normal. Soybeans are quite drought resistant once established. Frequently, a single 4-inch application with flood irrigation or a series of smaller applications with sprinklers in the late bloom to early bean-filling stage is all that is needed to supplement natural rainfall.

Growers on the fine-textured soils (clays) in the eastern part of Kansas should be more careful about irrigation. The greater likelihood of rainfall and the slow drainage of these soils can cause problems. Irrigation scheduling for these conditions should not allow the soil to become saturated but allow for some reserve soil water storage in case of rainfall. This reduces irrigation costs and prevents drainage problems.

Coarse-textured Soils

Coarse-textured soils (sands) have a much lower water-holding capacity than the finer-textured soils, so soybeans on sandy soils require much more frequent irrigation. Irrigation may be required at any stage of growth, with the amount and timing adjusted to the depth of rooting and the weather. Soybeans may require 1 to 2 inches of water every 3 to 7 days during the peak use periods. Sandy soils usually have good to rapid intake rates so they may be irrigated quickly, although some sandy soils in Kansas can crust and present problems with water intake.

Water Quality

Soybeans are rated as moderately tolerant to irrigation-water salinity. As a comparison, grain sorghum and

corn are rated almost the same (grain sorghum slightly more tolerant, corn slightly less). Wheat is moderately tolerant to tolerant. Alfalfa is rated moderately sensitive. These ratings only serve as a guideline to relative tolerance of crops. Absolute tolerance varies due to a number of factors including climatic conditions, soil conditions, and cultural practices.

The total concentration of soluble salts in water can be expressed in terms of the electrical conductivity. This can be measured for the soil water or the irrigation water to be applied. For example, a soil water electrical conductivity of saturation extracts (EC_e) of 5.5 millimhos per centimeter ($mmhos \div cm = dS \div m$) would cause a yield reduction of 10 percent in soybeans.

The electrical conductivity of the irrigation water (EC_w) that would cause yield reduction is less than EC_e . This is because soil water has a salt load due to contact with soil salts. The salt in the irrigation water will be an addition to the amount already in the soil water. Irrigation water with EC_w of greater than 2 millimhos per centimeter generally starts to enter a high-salinity hazard range. It is important to have your irrigation water tested before planting soybeans. The sodium content of the water also is a concern, but it is not addressed here. A local county agent or agricultural consultant can provide additional information on irrigation-water quality.

Soybeans should not be planted on soils with a high pH (greater than 7.5) because it makes them susceptible to iron chlorosis, which stunts growth and reduces yield potential. Foliar sprays containing iron and manganese chelates may mitigate the problem, but yields would still be low. More research may be needed to evaluate the effectiveness of foliar sprays against iron chlorosis under limited irrigation.

Soybeans irrigated using poor-quality water through sprinkler systems may be subject to additional damage when the foliage is wetted by the saline water. Salt accumulates on leaves due to evaporation of water from leaf surfaces, causing premature senescence or leaf drop. During the rapid-growth stage (see Figure 10), replacement leaves are grown, but early leaf drop late in the season can result in severe yield loss.

Irrigation options for poor-quality water are either completing all irrigation before all new leaf growth occurs or changing the irrigation system delivery method. Early cutoff of irrigation conflicts with the general irrigation recommendation of late water applications for best yield,

especially on sandy soils. This option may be possible on soils with high soil water-storage capacity. Several irrigators have attempted to modify their sprinkler packages by equipping sprinkler systems with drag lines. These deliver the water directly to the ground and do not wet the soybean canopy. However, this option must be accompanied by use of appropriate cultural practices to prevent runoff of irrigation water. This may mean use of such activities as maintenance of heavy residue, deep chiseling, furrow diking, or planting in circular rows. These cultural practices increase surface water storage capability and reduce runoff potential. Increasing pivot speed to reduce application depth also helps limit runoff problems.

Crop Rotation

The potential benefit of crop rotation may be a consideration. From an irrigation standpoint, irrigators with limited water supplies usually find that soybeans complement corn irrigation, since their critical water period is later in the season than the critical tasseling period for corn. Both crops often benefit from the rotation, not only from the water use standpoint, but also from other agronomic traits. Soybeans also can be used as a late-season double crop with wheat.

Irrigation Summarized

Soybeans are a good irrigated crop option with good yield potential for both full- and limited-irrigation regimes. Peak daily water-use rates for soybeans are about 0.30 inch per day, with total seasonal water needs ranging from 18 to 24 inches. Soybeans have an extensive root system and are drought tolerant. When limited water is available, late season irrigation is generally most important.

References

Marais, D. and M. Bufé. 2013. *A summary of the effects of growth stage scheduled irrigation in soybean*. University of Pretoria, South Africa. For the Protein Research Foundation, August 2013.

Related Publications from Kansas State

University Research and Extension

L934, *Agricultural Crop Water Use*

L935, *Important Agricultural Soil Properties*

MF3066, *Efficient Crop Water Use in Kansas*

KanSched – An ET based irrigation scheduling tool.

Available at www.bae.ksu.edu/mobileirrigationlab/



Soybean Insects







Soybean production in Kansas is an ever-changing endeavor. When this guide was published in 1997, Randy Higgins, entomologist, the author of this chapter, wrote, “One advantage of growing soybeans in Kansas is the crop is relatively free of serious insect problems.” Now it seems the crop is challenged by insect/mite pests from the seeding stage (V1) all the way to R8, maturity.





Fortunately, soybeans seem to be quite tolerant of damage, especially to foliage feeding, and can withstand 40 to 60 percent defoliation in the vegetative stages with little affect on the plant.





Insect pests can cause problems in soybean fields by defoliating the plants, which is the most common type of insect feeding, or by feeding on the pods or seeds within the pods. Pod and seed feeding can be devastating to yields, simply because they destroy the marketable product. Feeding on the pods by bean leaf beetles, most commonly, can expose the seeds to desiccation and pathogens. Corn earworms (soybean podworms) reduce yield by feeding directly on the seeds within the pods, as do stink bugs, by sucking the sap from developing seeds.

Table 10. *Insect and mite pests of Kansas soybeans.*

Pest	Description	Damage	Treatment Threshold
<p>Bean Leaf Beetles</p> 	<p>Wing covers have six black spots with a black border and a black triangle behind the thorax. Background may be tan or red. Larvae look like larval corn rootworms and feed on soybean roots.</p>	<p>Adults chew round or oval holes in leaves. Often feed on the exterior of pods.</p>	<p>Seven beetles per row foot on plants with fewer than four nodes, or if pod feeding results in the loss of three or more seeds per plant.</p>
<p>Blister Beetles</p> 	<p>Many sizes and colors, but all have a distinctive shape. Cylindrical body with wings that do not completely cover the abdomen.</p>	<p>Defoliation may occur but usually only in localized areas.</p>	<p>Rarely needs treatment; however, 20 percent defoliation at pod fill may justify spot treatment.</p>
<p>Dectes/Soybean Stem Borers</p> 	<p>Larvae are white, cylindrical, and legless. They spend their life inside stems. Adults are gray with long, dark banded antennae.</p>	<p>Larval tunneling and eventual girdling of main stem may cause lodging.</p>	<p>There is no treatment threshold or commercially available resistance. Harvest as early as possible to avoid lodging.</p>

Pest	Description	Damage	Treatment Threshold
Garden/Soybean Webworms 	Greenish caterpillar with three spots on each side of each body segment with a spine(s) growing out of them. Larvae move backward when disturbed.	Web together and skeletonize leaves. Usually occurs in vegetative stage in localized areas.	Treat if 50 percent of plants are defoliated and larvae are still shorter than ½ inch during vegetative stages or 25 to 35 percent defoliation during pod set.
Grasshoppers 	Crop pest species have short antennae and are yellow or greenish with long back legs.	Cause irregular holes and feed on leaves and pods usually from late July through September.	If more than 50 percent defoliation during pod set or enough pod feeding occurs to destroy three seeds per plant, treatment may be justified.
Green Cloverworms 	Light-green caterpillar with three white stripes on each side. Larvae have three pairs of legs near head, three pairs in middle of body, and one pair at the body's end.	Cause irregular holes in leaves and can cause major defoliation.	Treat if more than 35 percent defoliation occurs during pod set and no white, fungal infected larvae are present.
Pillbugs 	Not insects – These are the familiar roly polys, a type of crustacean. Gray, segmented, roll into semi-ball when disturbed, and have seven pairs of legs.	Feed on seedling stems causing plant death and stand loss.	Only consistently a problem in no-till fields. Insecticide seed treatments may help.
Potato Leafhoppers 	Small, lime-green, wedge-shaped insects that are very wary, and move in quick herky-jerky sideways movements. Have a characteristic white spot on head, and piercing-sucking mouthparts.	May cause leaf cupping/wrinkling and/or color change from green to yellow brown.	Even though potato leafhoppers can be found in most soybean fields every year, they have never reached densities requiring treatment.
Spotted Cucumber Beetles (Southern Corn Rootworm) 	Yellow to light green background with 12 black spots on back but no black border or black triangle behind the thorax as seen on the bean leaf beetle.	Adults are common in soybean fields and often mistaken for bean leaf beetles. They may do a little leaf feeding but mainly feed on pollen.	Do not need treatment threshold as they are not an economic problem.

Pest	Description	Damage	Treatment Threshold
Soybean Aphids 	<p>Tiny lime-green aphid with characteristic black cornicles (tailpipes). Only aphid that successfully colonizes soybeans in Kansas.</p>	<p>Piercing-sucking mouthparts remove plant sap; may cause leaf yellowing or death and reduced pods. Have not been consistent problems with these aphids.</p>	<p>50 or more aphids per leaf in vegetative stages to 250 per plant in R1 to R4 stages could justify treatment.</p>
Soybean Podworms (Corn Earworm) 	<p>Larvae usually tan or light green with tan head. Relatively smooth but with characteristic microspines (hairs) that are visible without magnification on larger larvae.</p>	<p>Larvae may feed directly on seeds within pods from August into October.</p>	<p>When larvae are feeding on seeds, it only takes one per row foot to justify treatment.</p>
Stink Bugs 	<p>Green or brown triangular shaped with rounded backside. Immatures (nymphs) of green stink bugs are black with reddish, yellow and/or green markings depending on instar. Brown stink bug nymphs are yellow and brown or tan only.</p>	<p>Cause yield loss by inserting mouthparts into developing seeds and sucking out the sap, which may result in smaller and/or deformed seeds.</p>	<p>Treatments should be applied when pods are filling if there is at least one bug per 3 row feet. Stink bugs are usually found in localized areas only.</p>
Thistle Caterpillars (Painted Lady) 	<p>Larvae usually clustered while small. Mostly light colored with black and yellow stripes with rings of spines. Adult butterflies have reddish wings with black and white markings.</p>	<p>Larvae may web together and skeletonize leaves but generally only in localized areas.</p>	<p>Treat when there are 10 or more larvae per row foot and/or there is more than 35 percent defoliation by worms that are shorter than 1/2 inch at pod set.</p>
Thrips 	<p>Light tan, yellowish to brown, very slender and quick moving. Adults have two pair of fringed-wings and all stages have rasping-sucking mouthparts.</p>	<p>Most damage occurs early and during dry conditions after wheat starts to senesce. Scraping away the leaf surface causes leaf/plant desiccation.</p>	<p>Seed treatments can be effective for up to 28 days after planting. Foliar applications have not been needed so no threshold has been established.</p>

Pest	Description	Damage	Treatment Threshold
<p data-bbox="126 226 440 260">Two-Spotted Spider Mites</p> 	<p data-bbox="704 226 987 470">These tiny arachnids have eight legs, appear oval shaped, and usually have two spots on each side of their body, made up of ingested food, giving them their name.</p>	<p data-bbox="1010 226 1239 537">Piercing-sucking mouthparts suck sap from individual plant cells causing leaf mottling, then yellowing to grayish-green, then brown, and eventually leaf drop.</p>	<p data-bbox="1258 226 1487 470">Miticides may be justified if 50 percent of foliage is prematurely dropped from plants from bloom to pod set.</p>
<p data-bbox="126 560 412 594">Woollybear Caterpillars</p>  	<p data-bbox="704 560 987 869">Extremely hairy, large caterpillars; may be yellow, orange, brown, or brown striped. Adults are relatively robust moths of several colors, but most are white and have black spots on the wings.</p>	<p data-bbox="1010 560 1239 764">Can cause defoliation but usually in localized areas within fields, and usually in August to October in Kansas.</p>	<p data-bbox="1258 560 1487 835">Generally densities don't reach treatable thresholds, but if greater than 50 percent defoliation occurs during pod set, treatment may be justified.</p>
<p data-bbox="126 1148 675 1218">White Grubs, Wireworms, Seedcorn Maggots, and Seedcorn Beetles</p>  	<p data-bbox="704 1148 987 1633">White grubs (pictured top) are fat and C-shaped with tan heads. Seedcorn maggots are white, maggot-like. Seedcorn beetles are tan with three pairs of legs and more wireworm-like except smaller. Wireworms (pictured bottom) are tan, multiple segmented, hardened, and move quickly.</p>	<p data-bbox="1010 1148 1239 1352">All are soil-inhabiting worm-like larvae. Feed on seeds, tender young stems, and/or roots, causing stand loss.</p>	<p data-bbox="1258 1148 1487 1423">Generally more problematic to corn producers, but any of these can be relatively well-managed with seed treatments (insecticides).</p>

Soybean Diseases

Historically, charcoal rot and soybean cyst nematode (SCN) were the two most important soybean diseases in Kansas. Recently, however, two other diseases — Pythium seedling blight and sudden death syndrome — have consistently resulted in significant yield losses for many Kansas soybean producers. Occasionally, when weather and growing conditions are suitable, other diseases including Phytophthora root rot, stem canker, frogeye leafspot, and Phomopsis pod and stem blight can cause economic yield losses in some Kansas soybean fields.

Variety Selection

Due to the introduction of traited seeds, producers are no longer able to carry over seed for planting from year to year, so past recommendations on seed handling are no longer pertinent. Variety selection, however, continues to be a key component of disease management. Yield is always the primary factor in selecting varieties, but where certain diseases are an ongoing problem in fields, producers should look carefully at disease tolerance and resistance ratings as key secondary traits in variety selection. Diseases that can be at least partially managed by variety selection and are often included in seed catalog ratings include SCN, sudden death syndrome, Phytophthora root rot, and frogeye leaf spot.

Crop Rotation

Since many soybean diseases such as frogeye leafspot, pod and stem blight, and brown spot can overwinter in infested crop debris, rotating soybeans with nonhost crops such as corn, sorghum, or wheat is a sound disease control practice. Other soybean diseases, such as Phytophthora root rot, charcoal rot, and SCN, can persist in the soil for several years, making crop rotation less effective. Even in these cases, rotation helps suppress the disease and limit yield losses.

Seed Treatment

Soil temperatures lower than 60 degrees Fahrenheit inhibit soybean growth and promote seed rot and seedling damping-off, particularly if soils remain wet. Other soil factors affecting emergence are soil type, crusting, depth of planting, and herbicide usage. Research conducted over many years in Kansas has shown the use of a fungicide seed treatment results in an average yield increase of approximately 2.5 bushels per acre. In years with good germination and early season growing conditions, there may be no advantage to seed treatment, but

in years when conditions favor disease development, yield increases can reach 10 or more bushels per acre.

Seed treatment fungicides can be divided into two general categories: contacts and systemics. Contact fungicides only control those fungi on the outer surface of the seed. Systemic fungicides, however, are absorbed into the germinating seed and provide additional protection as the plant emerges.

For decades, contact fungicides were the primary type used, and, when disease conditions were severe, they often failed. With the introduction of systemic materials, however, seed rot and seedling blight management has improved significantly. The current standard in the seed treatment industry is to use a cocktail of materials. Contact materials may still be included in the mix, but the trend has been to use primarily systemic materials. Usually the product contains metalaxyl, mefenoxam, or ethaboxam, specifically for the control of Pythium and Phytophthora diseases. Numerous other materials are used in various combinations depending on the manufacturer to combat other diseases including Rhizoctonia and Fusarium. Some seed treatment materials may be harmful to rhizobial inoculants; always read the label for specific recommendations about using inoculants with a particular seed treatment product

Foliar Fungicides

Since the introduction of soybean rust into the United States, it has become much more popular to apply fungicides to a soybean crop. The strobilurin group of fungicides has certain growth-promoting effects and has been vigorously marketed for use even in the absence of disease. Data collected from years of university research throughout the soybean production region have shown that while there can be some yield increase, it is generally not large enough to cover production costs in the absence of disease.

Currently, frogeye leafspot is the only foliar disease in Kansas for which a management plan would include a foliar fungicide application. Tebuconazole, a triazole mode of action fungicide should be used with caution if applied on days when temperatures exceed 100 degrees Fahrenheit. The product can cause a foliar burn that produces symptoms similar to those of sudden death syndrome (See *Sudden Death Syndrome* below).

Seedling Diseases

Seedling disease refers to a large group of soil- and seed-borne organisms that attack the soybean seed

before germination or during the early stages of growth. Common seedling blight pathogens in Kansas include *Pythium*, *Rhizoctonia*, *Fusarium*, and *Phytophthora*. Other diseases, including sudden death syndrome and charcoal rot, can infect the plants at this time, but symptoms do not develop until much later stages of crop growth when weather conditions may become suitable.

Symptoms for all of the organisms are similar. They include seed rot, pre- and post-emergence damping-off (a constriction of the stem at or below the soil line), and yellowing and stunting of young seedlings. Situations favoring disease development include poor-quality seed and adverse growing conditions caused by wet soil, compaction, or cold soil temperatures (lower than 60 degrees Fahrenheit). Management practices include planting when conditions promote rapid emergence, planting at the correct depth, and the use of a commercially applied seed treatment.

Fungal Diseases of Roots and Lower Stem

Charcoal Rot. The fungus causing charcoal rot survives in the soil and directly infects the plant's roots. Severe losses occur frequently on nonirrigated soybeans, especially during hot, droughty periods. The disease is most common in eastern Kansas, but has extended westward in recent years as more western Kansas producers have introduced soybeans into their rotation, especially in nonirrigated or limited irrigation management systems.

Plants initially wilt in the midday heat but recover at night. Eventually, they begin to turn yellow until the wilt becomes permanent and they die; however, the leaves remain attached (Figure 14). The symptoms are easily confused with drought stress. With charcoal rot, however, small, black, fruiting structures known as sclerotia form on the lower stem and in the pith. Any management practice that promotes moisture conservation (reduced



Figure 14. A field showing symptoms of charcoal rot.

seeding rates, no-till, weed control, or irrigation) reduces losses. All varieties are susceptible, but late-maturing varieties are more tolerant than early-maturing varieties.

Sudden Death Syndrome (SDS) Soybean sudden death syndrome (SDS) is caused by a soil-inhabiting species of *Fusarium*. Infection generally occurs early in the season, but symptoms do not usually develop until the reproductive phase is reached. Cooler, wetter weather starting around R1 seems to trigger symptom development. In Kansas, the disease is most severe in irrigated fields.

Although it is a root pathogen, the fungus produces a toxin that is exported to the upper portions of the plant and is responsible for the characteristic foliar symptoms. On the leaves, small cream-colored spots between the veins are the first sign of disease. Over a few days, these spots coalesce and the entire area of the leaf between the veins turns brown, while the veins themselves remain green (Figure 15). The leaf blades will drop off, but the petioles remain attached. Other problems such as stem canker, brown stem rot and foliar burn from tebuconazole can cause similar foliar symptoms.

SDS can be positively identified by splitting the tap root. With SDS, there will be a gray to brown discoloration of the inner tissue of the root. Many secondary roots also may be rotted away, making it easy to pull plants out of the ground. SDS generally occurs in fields previously infested with SCN. As the nematode burrows into the root, it apparently provides an ideal pathway for the fungus to enter the root. SDS is best managed by avoiding early planting into cool, wet, and compacted soils.

SDS tolerant varieties are available, but under severe conditions, even the most tolerant varieties develop symptoms, although yield loss is much lower than with more susceptible varieties. ILeVO, a new seed treatment product containing the active ingredient fluopyram, has recently been registered in Kansas and provides very good



Figure 15. Leaf browning caused by soybean sudden death syndrome.

management of the disease. Because of its cost, however, it should only be used in fields with a known history of the disease.

Phytophthora Root Rot. *Phytophthora* may occur any time during the season following a period of prolonged soil wetness. The fungus survives in the soil and produces swimming spores that infect roots. *Phytophthora* symptoms include pre- and post-emergence damping off. Older plants may turn yellow and leaves may wilt. Roots usually appear rotted and a brown discoloration extends from the soil line up into branches and petioles (Figure 16).

Conditions encouraging disease include poorly drained soil, flooding from heavy rains, or overirrigation. Resistant or field-tolerant varieties are the best means of management. There are many races of *Phytophthora* and varieties should be selected accordingly. Currently, varieties with the *rps1k* and *rps1c* sources of resistance provide the broadest spectrum of protection; however, since it is usually not known what races may be in a particular field, using a variety with an excellent field tolerance score may be more practical. Any improvements in drainage also will help. While seed treatments may provide some protection against the seedling blight phase of the disease, there are no in-season products available to control the later phases of the disease.

Pod and Stem Blight. Yield losses from this disease are infrequent, but seed quality can be greatly reduced. The fungus survives in diseased stubble or is seed-borne. At maturity, symptoms appear as vertical rows of small black spots on the stem or pods. Seeds may be cracked, shriveled, or moldy. The disease is favored by high humidity and rainfall, especially late in the season. The disease can be managed using crop rotation and destroying infested debris by tillage. Fungicides



Figure 16. *Phytophthora* root rot symptoms are characterized by a chocolate-brown stem lesion that starts at the soil line and moves upward.



Figure 17. Leaf browning caused by stem canker.

can reduce yield losses and improve seed quality, but symptoms are not yet present at the time the decision to spray needs to be made (R5), making cost-effective use difficult.

Stem Canker. Stem canker is occasionally a problem in Kansas, although it is easily confused with *Phytophthora* root rot (Figure 17.). The fungus either survives in stubble or can be seed-borne. Spores are windblown or are splashed by water onto plants. Sunken, brownish cankers with dark, reddish-brown margins form on lower nodes with green stems above and below the canker. The canker is usually on one side of the stem but can girdle the stem, causing the upper portion of the plant to wilt and die. The upper part of the plant may curl over, giving it a shepherd's crook appearance. Crop rotation, removal of debris, and use of tolerant cultivars can aid in management.

Fungal Diseases of Foliage, Upper Stems, and Pods

Frogeye Leafspot. This disease is becoming increasingly common in Kansas soybean fields and has the potential to cause serious yield losses, ranging from 10 to 50 percent on the most susceptible varieties. On leaves, small, circular, tan spots surrounded by a purplish ring are an indication of the disease's presence (Figure 18). Under wet, humid conditions, the disease can spread rapidly. While fungicide management is recommended when the disease is present, there are no well-established thresholds to help in making the decision to spray. The fungus causing frogeye leafspot has shown a remarkable ability to develop resistance to strobilurin fungicides, so fungicide management programs should include a product with a triazole mode of action.

Brown Spot. This disease is quite common early in the season but seldom persists until maturity, and yield



Figure 18. *Small, circular, tan spots surrounded by a purplish ring indicate the presence of frogeye leafspot.*

losses are minimal. It is seed-borne and survives in crop residue. The disease can spread rapidly through a field by the blowing and splashing of spores. Angular brown spots form on the lowest leaves first. Later, the leaves turn yellow and drop, giving the lower plant a barren appearance. The disease is most common in humid areas where rotation is not practiced. Crop rotation, removal of debris, and planting disease-free seed are recommended management practices. In Kansas, yield losses are such that fungicide management is not economical.

Downy Mildew. Light infections are frequent in Kansas when susceptible varieties are planted. Severe infections are rare but can occasionally result in smaller seed size, low test weight, and poor quality. The fungus can survive on infested leaf debris and on seeds. Spores are spread by wind or rain splashing. Symptoms appear as pale-green to light-yellow spots. On the lower surface, tufts of grayish mildew develop. Some leaves may yellow and drop. The seed and inner pod surface may be coated with whitish mold without exterior pod symptoms. The disease is favored by high humidity and cool temperatures. Young leaves are most susceptible, and late plantings usually have more disease because spores are more abundant. Crop rotation and resistant varieties help manage the disease.

Cercospora Leaf Blight/Purple Seed Stain. Foliar symptoms consist of a purplish discoloration of the tip end of leaves that could be confused with some nutritional disorders. Seed infection takes place when rain occurs during flowering. Seeds are stained with a purplish-brown color, reducing quality (Figure 19). Disease management includes planting disease-free seed, using resistant cultivars, and seed treatment. Like pod and stem blight, fungicide management is difficult since presence of foliar symptoms does not correlate well with seed staining. By the time conditions become favorable

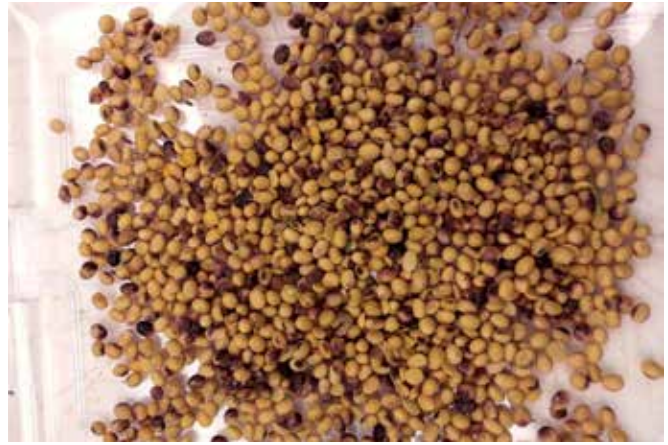

Figure 19. *Purple-brown staining on seed caused by purple seed stain.*

for the seed stain phase to develop, it is generally too late to apply a fungicide.

Soybean Rust. Soybean rust has occurred only once in Kansas since its introduction into the United States in 2004. Symptoms usually begin at mid-canopy after flowering has begun. Small, gray spots form on the underside of leaves. The spots increase in size over time and change color to tan, reddish-brown, or black. The pustules are raised on the underside of the leaf. As disease progresses, defoliation eventually occurs. The disease responds well to fungicides. There is a well-established monitoring system in the United States and growers should have adequate time to begin scouting and make spray decisions should the need occur again in the future. Double-cropped soybeans are most likely to be threatened by this disease should it reoccur.

Bacterial Diseases

Bacterial Blight. This disease occurs in most fields, but rarely is moisture consistent enough for losses to occur. Bacteria are seed-borne and survive in crop residue. Bacteria are commonly spread during storms containing high winds and heavy rains. Symptoms include small, water-soaked leaf spots that turn brown and have a yellow border. As spots coalesce, the tissue falls out, giving the leaves a torn and ragged appearance. Crop rotation and avoiding field operations when the foliage is wet are important management tools. Fungicides are not effective on bacterial diseases.

Bacterial Pustule. This disease is similar to bacterial blight. The key diagnostic features are the development of raised pustules in the center of lesions on the underside of the leaf and the tattered appearance of the leaf does not occur. This disease generally develops later in the season when temperatures are warmer. Some resistant cultivars are available; otherwise, management is the same as for bacterial blight.

Viral Diseases

Bud Blight/Tobacco Streak Virus. These two viral diseases have nearly identical symptoms and can only be positively identified by special laboratory testing. Bud blight has been the most common of the two in Kansas.

Caused by tobacco ringspot virus, this disease is occasionally present in low incidence. The disease is easily transmitted mechanically. Immature thrips also may vector the disease. Many weed hosts can serve as reservoirs for the disease.

Infected plants are dwarfed. The pith in the upper nodes turns brown. Pods may develop brown blotches and seed development may be inhibited. There is often a distinct curling of the uppermost stem tip. Infected plants often remain green until frost. Management of the disease includes using disease-free seed, controlling weeds in and around the field, and roguing of infected plants. Tobacco streak virus is considered an emerging disease in the western soybean belt and was first reported in Kansas in 2015. Pathologists will continue to study it to determine how large a problem it may be.

Bean Pod Mottle Virus. Along with bud blight, this is the other most common virus in Kansas. It is transmitted by the bean leaf beetle. Young leaves in the upper canopy develop a light green to yellowish mottle or mosaic pattern. Puckering or distortion of the leaves also may occur. Like bud blight, plants will remain green, late in the season, with few, if any, pods present. Controlling the first generation of bean leaf beetles in the spring may limit inoculum for later season infection, but there is no research indicating economic loss from the virus.

Soybean Vein Necrosis Virus (SVNV). The newest virus to Kansas was originally discovered in Tennessee, but it has now moved to many of the major soybean producing states. It is spread by the soybean thrip and possibly other thrip species. SVNV lesions start as a yellowing along a leaf vein. Eventually the yellowing becomes red-brown, producing irregularly shaped lesions on the leaf. The yellowing may expand away from the vein but typically does not extend across other major veins. SVNV can look like several other foliar diseases, so caution should be taken in making a diagnosis. It generally requires laboratory confirmation for its identification.

Nematode Diseases

Soybean Cyst Nematode (SCN). SCN continues to spread across Kansas. The most recent state survey indicated that about 20 percent of Kansas fields are infested. In Cherokee County, however, the infestation level is 95 percent, and in Doniphan County, it is 75 percent. SCN is most often spread by infested soil on field machinery, but in reality, it can be spread by any means in which soil is moved. Seed grown in infested areas containing soil peds also can spread the disease. Severe infestations may result in plants that are stunted and yellow with reduced nodulation. In these instances, symptoms are easily confused with drought, flooding, herbicide injury, compaction, or nutrient deficiency. In most fields, however, the only symptoms present may be some uneven growth and a gradual production decline over time. Crop rotation and the use of resistant varieties are the keys to management.

Several races of the nematode occur in Kansas, so rotating the sources of resistance in varieties is important. New seed treatment nematicides have become available in recent years, but their cost-effective use in SCN management is still being evaluated. While nearly all available soybean varieties have some level of resistance, it is well documented that their performance may be dependent on the particular population of the nematode in a field. That is, a variety that may provide good resistance in Clay County may perform no better than a susceptible variety in Shawnee County. Therefore, continual monitoring of nematode populations is recommended so adjustments in variety selection can be made if necessary. SCN is also a known predisposition agent for the development of SDS in soybean fields. Varieties resistant to SCN may not be resistant to SDS and vice versa.

Photo Credit

Figure 16. Courtesy A. E. Dorrance; Reproduced, by permission, from Hartman, G. L., et al., eds. 2015. *Compendium of Soybean Diseases and Pests*. 5th ed. American Phytopathological Society, St. Paul, MN.

Figure 17. Courtesy D. Ploper; Reproduced, by permission, from Hartman, G. L., et al., eds. 2015. *Compendium of Soybean Diseases and Pests*. 5th ed. American Phytopathological Society, St. Paul, MN.

Drying and Storage

Drying Considerations

Soybeans can be harvested at 16 to 18 percent moisture content without damage if the plants have frosted or died. The beans must be dried to less than 14 percent moisture content before storing. Germination is reduced when seed beans dry and re-wet several times before harvesting. Drying systems used for corn or grain sorghum are adaptable to soybeans. Soybeans are fragile and can be damaged by air that is too hot or too dry and by rough handling. Three common methods for drying soybeans are natural air, low temperature, and high temperature.

Natural air involves moving unheated outdoor air through a bin of soybeans. Only one to two points of moisture can be removed with a natural air drying system. Little natural air drying occurs unless outdoor air temperature is greater than 60 degrees Fahrenheit and relative humidity is below 75 percent. The successful use of unheated air depends on the available airflow rate per bushel of beans and favorable weather conditions. If the soybeans can be dried, their quality is excellent unless there is handling damage. Bins should be equipped with a fully perforated floor and fan unit. Fans capable of delivering 1 to 2 cubic feet of air per minute per bushel of soybeans (cfm/bu) are required.

Low-temperature drying is similar to natural air. Low-temperature drying can be used when drying soybeans for seed and is best suited when only 3 to 4 percentage points of moisture are removed. The outdoor air is heated 5 to 20 degrees Fahrenheit with low-temperature drying. This reduces the humidity of the drying air about 10 to 20 percent. Bin depth is limited to 16 feet and air flow rates are 1 to 2 cubic feet per minute per bushel. The humidity of the drying air should range from 40 to 70 percent.

High-temperature dryers, such as batch dryers, continuous-flow dryers, or in-bin dryers, can be used to dry commercial soybeans or those used for oil or meal, but not seed soybeans. The recommended maximum temperature of the drying air is 140 degrees Fahrenheit. If quality (few splits or no change in the oil's free fatty acid content) is important, the drying process should be controlled by maintaining the relative humidity greater than 40 percent rather than controlling temperature. Drying temperatures greater than 110 degrees Fahrenheit and 140 degrees Fahrenheit will affect germination and oil content, respectively. Excessive heat decreases the drying air relative humidity, which causes damage to the seed coat or pericarp cracking and results in splits. Seed coat cracking and splits may occur if the relative humidity

of the drying air is less than 40 percent. Split soybeans are more susceptible to mold and fungi than whole beans.

Storage Considerations

Beans must be uniformly dried to less than 14 percent moisture if stored less than 6 months and 11 percent moisture for longer storage. Good-quality, clean soybeans can be stored at higher moisture content than damaged beans. The storage moisture content is dependent on the temperature, moisture content, length of storage, and soybean quality (Figure 20).

Storage problems often can be traced to areas where pockets of foreign material, fines, or weed seeds have accumulated. Such pockets provide a place for insects and molds to live, and they inhibit effective aeration and fumigation. Excessive foreign material and fines restrict the airflow through the soybeans. Spoutlines can contain up to 80 percent weed seeds. Germination losses of seed soybeans are more likely due to pockets of excessive splits and foreign material rather than unsafe average storage temperatures and moisture. These pockets of material tend to be at higher temperatures or moisture contents. Molds and fungi are able to grow and invade viable beans in these pockets and kill their germination. These dead seeds are then mixed with viable soybeans, so the average germination is reduced.

Good storage management can greatly influence the storability of soybeans. Information on grain protectants and fumigants and bin wall sprays for use with soybeans can be obtained from the area or state K-State Research and Extension entomologist or county agents. Successful storage of soybeans involves sanitation, aeration, and monitoring.

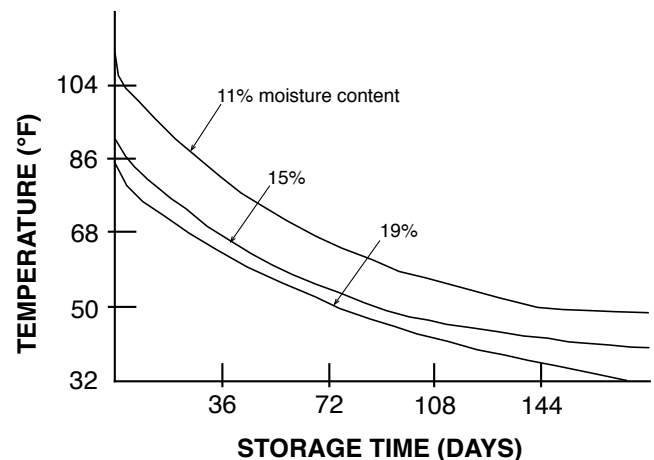

Figure 20. Safe storage time for soybeans (seed) based on an 80-percent germination.

Sanitation ensures soybeans are harvested, transported, and handled with clean equipment and stored in a clean structure. Combines, transportation equipment, and conveying equipment should be cleaned of infested soybeans or other grains before harvest. Sanitation in storage structures involves sweeping, cleaning, and removal of old soybeans or grains both inside and outside the storage structure. To avoid contaminating newly harvested beans, remove and destroy leftover debris from bins and sweep the walls, ceilings, sills, ledges, and floors.

Trash, old machinery, and litter around the bin areas should be removed. No vegetation should be within 2 feet of the storage structure. Another source of infestation is the spilled grain around the loading and unloading equipment. A weatherproof seal or other bin repairs, particularly where sidewalls join the floor and roof, are needed to prevent moisture or rodents from entering the storage structure.

Soybeans stored for more than 3 months at 14 percent moisture or less, should be placed in a bin equipped with an aeration system. Aeration reduces the temperatures inside a bin to 40 degrees Fahrenheit using outside air. Aeration controls grain temperature to prevent spoilage, mold and insect activities, and moisture migration. This is accomplished by an aeration system that provides a reasonably uniform airflow of about 0.1 to 0.5 cubic feet of air per minute per bushel or a drying system.

Aeration is not a drying process, although small moisture changes do occur with a change in temperature. During aeration (cooling or warming) a temperature zone moves through the beans much like a drying front during drying, only much faster. It is recommended to begin aeration immediately following harvest to remove field heat and equalize temperatures within the storage structure. Aeration fans can be controlled manually or with controllers. The electronic controllers can be used with natural air or low-temperature drying operations and aeration. Simple thermostatic controllers can only be used with aeration. Aeration controllers typically reduce the average temperatures in a bin 4 to 6 weeks quicker than manual operation. This time difference is dependent upon whether the beans are harvested in early or late fall. Electronic controllers provide several management strategies to choose from depending on moisture content, temperature, and storage time.

Soybeans should be maintained at 40 degrees Fahrenheit during the winter and 50 to 60 degrees Fahrenheit during the summer. To cool the beans in the fall, the average outside temperatures (average of high and low for a day) should be 10 to 15 degrees Fahrenheit less than soybean temperatures. The fan should run continuously until the beans are completely cooled unless a controller is used. At 0.1 cubic feet of air per bushel,

the fan will have to run about 120 hours to move a cooling cycle through the bin. To be sure the beans are cooled, however, the temperature of the beans should be measured at several points within the bin.

Frequent monitoring or observation is the best way to detect unfavorable storage conditions. The soybeans should be checked weekly from April to November and biweekly from December to March. Operating a fan for about 20 minutes during monitoring helps determine the conditions. Be observant for odors, steam, water vapor, heat, and moisture condensation while the fan is on. A faint musty odor is often the first indication of spoilage. This is particularly true during the spring when heating may be occurring due to warm weather or molds and insects. If steam, water vapor, or heat is observed, the soybean quality has deteriorated. The aeration fans should be turned on immediately to recool the soybeans, and the soybeans should be marketed immediately. Fans should be operated during the spring to equalize the temperatures within the bin. The spring target temperature is 50 degrees Fahrenheit.

Proper monitoring requires a grain probe, a section of eaves trough or a strip of canvas for handling the grain from the probe, screening pans for sifting insects from the grain samples, and a means of measuring temperatures in the grain. A record book of grain temperatures can help in detecting gradual increases in grain temperature. Slight increases are an early sign that heating and potential spoilage may be occurring. Thermometers or temperature monitoring systems can be used to measure the grain temperature.

Storage Facilities

Soybeans can be stored on the farm in round bins or regular, concrete-floor buildings. Drying is risky in flat storage because of the possibility of poor air distribution. Beans held in storage, even though dry, need periodic aeration to minimize moisture migration and break up any hot spots that might develop. Flat storage does, however, have more versatility for other uses.

Beans must be moved carefully as they are more susceptible to cracking and breakage than most grains. Augers should be operated at low speeds and full capacity to minimize damage. Belt conveyors are better than augers for moving beans. Grain augers are manufactured with bristles on the flighting to reduce the damage during handling. The bristle augers do not work in seed conditioning operations where avoidance of cross contamination of seeds is critical. Handling should be minimized and controlled by limiting drop heights and conveying. Grain spreaders should only be used with commercial beans and avoided when handling seed beans. Bin ladders can be used to reduce the damage due to drop distance during bin filling.

Profit Prospects

Total harvested soybean acres in Kansas averaged 3.71 million acres between 2008 and 2013. The largest harvested acreage occurred in 2010 with 4.25 million acres and has been declining in the years since. In 2013, Kansas ranked 11th in the United States in the production of soybeans with 1.593 billion bushels harvested from 3.54 million acres.

Each producer must answer two questions when selecting crops and the acreage of each crop to produce: (1) Will this choice be profitable? (2) Will this add more to the total net income of my farm operation than other choices? That is, is this the most profitable choice?

The fixed or overhead costs of land and machinery ownership for soybeans, corn, grain sorghum, and wheat will be basically equal for a few years. Therefore, a short-run analysis of the variable costs associated with each crop needs to be considered when selecting a given crop. Variable costs include labor, machinery repairs, seed, crop insurance, fertilizer, custom work, fuel and oil, cash rent paid to landlords, herbicides, insecticides, and miscellaneous expenses.

Variable costs differ depending on the management practices used, tillage operations, labor efficiency, and soil type and fertility of the land. Each producer needs to quantify his or her own variable costs of production for soybeans and any other crop alternatives. Expected yield and selling price also have to be determined for each crop alternative.

Budgeted variable costs by item are shown for nonirrigated soybean production in south central, north central, northeast, and southeast Kansas and for irrigated soybean production.¹ These cost estimates were obtained from the Kansas Farm Management Association enterprise budgets for the years 2008 to 2013 (available at: www.agmanager.info/kfma). These estimates are not projections, but rather averages of actual costs incurred by

producers in each region. A producer may have higher or lower costs than those presented in these budgets.

The prices used in these tables are **not** price forecasts, rather they are a marketing year average of cash prices received by farmers in the region. They are used to indicate the method of computing expected returns above variable costs. The projections should be considered valid only under the costs, production levels, and prices specified. Individuals or groups using the information provided should substitute costs, production levels, and prices valid for the locality, management level to be adopted, marketing circumstances for the location, and time period involved.

The decision to plant soybeans or another crop alternative can be made by comparing the expected returns above variable costs for each crop, assuming fixed costs (i.e. depreciation, land costs) are roughly the same for each crop. Returns above variable costs depend on yields and prices. Each producer should use yields that are reasonable for the land or classes of land operated.

The decision to produce soybeans depends primarily on the costs and expected returns for soybeans in comparison with other crop alternatives. The producer should take into account other variables such as previous crop rotation, livestock operation, and the machinery and labor requirements of each crop.

The type and amount of equipment, crop rotations, and farm size all affect the cost of producing crops. The tillage practices used and their timing also affect yields and production costs. Each producer should compute the expected returns above variable costs for the farm operation as a means of selecting the crops and acreage of each crop to produce. When computing expected returns above variable costs, consider a number of price alternatives.

Estimated Variable Costs of Production (2008-2013)*

	North Central	South Central	Northeast	Southeast	Irrigated	My Farm
Soybeans	\$200.75	\$166.52	\$287.46	\$193.23	\$291.81	_____
Corn	304.34	220.63	380.23	312.70	435.93	_____
Grain Sorghum	219.16	180.59	--	191.57	--	_____
Wheat	189.95	155.49	235.62	179.74	--	_____

* Cost estimates from the Kansas Farm Management Association

¹ Nonirrigated soybean production in western Kansas is not usually considered to be a profitable crop alternative, although it may be for a particular farm operation.

Estimated Variable Costs of Production (2008-2013)*

	North Central	South Central	Northeast	Southeast	Irrigated	My Farm
Yield per acre	36.16	36.59	47.665	30.425	50.915	_____
Local cash price**	\$11.46	\$11.40	\$11.67	\$11.80	\$11.76	_____
Returns:						_____
Yield per acre × cash price	\$414.21	\$417.13	\$556.01	\$358.86	\$598.51	_____
Government payments	\$11.64	\$23.63	\$11.07	\$9.98	\$10.06	_____
Total Returns	\$425.86	\$440.76	\$567.08	\$368.85	\$608.56	_____
Variable costs:						_____
Labor	8.01	3.51	4.65	9.97	13.58	_____
Machinery repairs	22.98	16.49	26.42	19.20	31.22	_____
Seed	50.53	35.71	57.45	42.35	59.73	_____
Crop insurance	12.35	9.69	13.67	13.32	13.38	_____
Fertilizer-lime	8.94	18.25	20.45	16.25	13.99	_____
Custom hire	5.23	4.28	12.12	6.94	9.48	_____
Fuel and oil-crop	16.06	10.22	17.88	16.27	21.71	_____
Cash rent paid	16.60	8.21	54.40	12.87	29.38	_____
Herbicide and insecticide	27.92	32.43	35.52	25.23	25.78	_____
Fuel and oil-pumping	0.00	0.00	0.00	0.00	19.41	_____
Irrigation repairs	0.00	0.00	0.00	0.00	10.61	_____
Miscellaneous	20.80	18.33	28.65	19.92	27.05	_____
Interest on variable costs (6%)	11.36	9.43	16.27	10.94	16.52	_____
Total Variable Costs	\$200.75	\$166.52	\$287.46	\$193.23	\$291.81	_____
Expected Returns Above Variable Costs	\$225.11	\$274.24	\$279.63	\$175.61	\$316.76	_____

* Cost estimates from the Kansas Farm Management Association.

** Cash price is an average price received by farmers.

North Central Kansas (2008-2013)*

	Yield (bu/a)	Cash Price	Government Payments	Gross Revenue	Variable Costs (\$/a)	Returns Over Var. Costs	Fixed Costs	Returns Over All Costs
Soybeans	36.2	11.46	11.64	425.86	200.75	225.11	104.23	120.88
Corn	103.4	4.46	13.44	474.56	304.34	170.22	128.87	41.36
Grain Sorghum	97.3	4.20	11.49	419.66	219.16	200.51	92.50	108.01
Wheat	52.6	6.63	11.01	359.68	189.95	169.73	89.75	79.98

* Cost estimates from the Kansas Farm Management Association

South Central Kansas (2008-2013)*

	Yield	Cash Price	Government Payments	Gross Revenue	Variable Costs	Returns Over Var. Costs	Fixed Costs	Returns Over All Costs
	(bu/a)				(\$/a)			
Soybeans	36.6	11.40	23.63	440.76	166.52	274.24	99.69	174.55
Corn	84.6	4.11	31.83	379.45	220.63	158.82	107.77	51.06
Grain Sorghum	92.5	3.95	19.20	384.55	180.59	203.96	100.44	103.53
Wheat	46.7	6.52	19.65	324.00	155.49	168.51	80.60	87.91

* Cost estimates from the Kansas Farm Management Association

Northeast Kansas (2008-2013)*

	Yield	Cash Price	Government Payments	Gross Revenue	Variable Costs	Returns Over Var. Costs	Fixed Costs	Returns Over All Costs
	(bu/a)				(\$/a)			
Soybeans	47.7	11.67	11.07	567.08	287.46	279.63	122.41	157.22
Corn	142.4	4.37	10.56	631.94	380.23	251.71	148.00	103.71
Grain Sorghum	--	--	--	--	--	--	--	--
Wheat	54.0	6.48	9.64	359.78	235.62	124.16	109.00	15.17

* Cost estimates from the Kansas Farm Management Association

Southeast Kansas (2008-2013)*

	Yield	Cash Price	Government Payments	Gross Revenue	Variable Costs	Returns Over Var. Costs	Fixed Costs	Returns Over All Costs
	(bu/a)				(\$/a)			
Soybeans	30.4	11.80	9.98	368.85	193.23	175.61	95.47	80.14
Corn	79.8	4.67	8.74	380.82	312.70	68.12	107.64	-39.52
Grain Sorghum	79.5	3.99	15.45	332.26	191.57	140.69	76.09	64.61
Wheat	50.9	6.78	10.30	355.01	179.74	175.27	80.85	94.42

* Cost estimates from the Kansas Farm Management Association

North Central Kansas Irrigated Crops (2008-2013)*

	Yield	Cash Price	Government Payments	Gross Revenue	Variable Costs	Returns Over Var. Costs	Fixed Costs	Returns Over All Costs
	(bu/a)				(\$/a)			
Soybeans	50.9	11.76	10.06	608.56	291.81	316.76	88.70	228.06
Corn	165.9	4.62	9.34	774.92	435.93	339.00	117.61	221.39
Grain Sorghum	--	--	--	--	--	--	--	--
Wheat	--	--	--	--	--	--	--	--

* Cost estimates from the Kansas Farm Management Association

Domestic and International Soybean Marketing

Soybeans are one of the primary crops produced in the United States, South America, and other parts of the world. They are a major food source worldwide. Predominant producers and exporters of soybeans are found in the United States, Brazil, Argentina, and Paraguay. The world soybean market has been affected by the expanded use of soybean coproducts for livestock and human consumption in a number of countries, but particularly China. Since the late 1990s, growth in demand for soybeans by China has been identified as one of two major factors affecting U.S. and world agriculture — the other being the expansion of starch ethanol production and its influence on U.S. corn production.

This chapter examines a number of primary supply/demand, price, and profitability trends in the United States and in Kansas (as a representative region of the western Corn Belt). It also examines trends in world soybean production, exports, imports, usage, and ending stocks over time.

The U.S. and world soybean market has been a dynamic, changing setting, with strong, predominant supply/demand trends driving prices on the margin, which in turn have affected profitability and world farmers' year-after-year choices for producing soybeans as opposed to other alternatives. The key issue to consider is the degree to which Chinese soybean import demand continues, with its strong positive influence on world soybean prices and farmers' ongoing production decisions into the future.

The information used in this chapter is available from the United States Department of Agriculture (USDA) online sources. These include the USDA World Agricultural Supply and Demand Estimates (WASDE) (www.usda.gov/ocel/commodity/wasde/), the USDA Foreign Agricultural Service Production, Supply and Distribution Online (PSD Online) (apps.fas.usda.gov/psdonline/psdhome.aspx), the USDA National Agricultural Statistics Service Quickstats data portal (quickstats.nass.usda.gov/), and the Kansas Farm Management Association enterprise records available on the Kansas State University AgManager website (www.agmanager.info/kfma).

Domestic Supply/Demand and Soybean Prices

Soybean Acreage in the United States

Planted soybean acreage in the United States averaged 76.028 million acres over the 2000-2016 time period, with a low of 64.741 million acres in 2007, and a projected high of 83.688 million acres in 2016 (Figure 21). Planted acreage of U.S. soybeans has trended higher at a rate of 592,978 acres per year over the 2000-2016 time period.

Harvested acreage of soybeans in the United States has averaged 75.035 million acres over the 2000-2016 time period, with a low of 64.146 million acres in 2007, and a projected high of 83.037 million acres in 2016

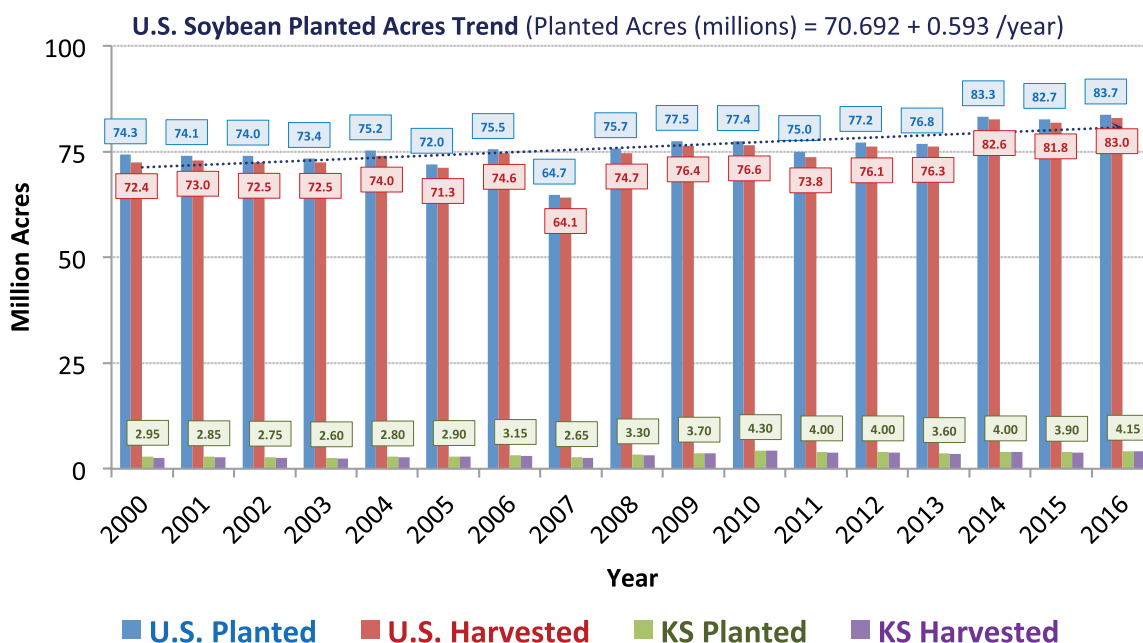

Figure 21. United States and Kansas Soybean Planted and Harvested Acreage (2000-2016).

(Figure 21). Harvested acreage of U.S. soybeans has trended higher at a rate of 634,596 acres per year over the 2000-2016 time period.

Soybean Acreage in Kansas

Planted acreage of soybeans in Kansas has averaged 3.388 million acres over the 2000-2016 time period, with a low of 2.6 million acres in 2003 and an estimated high of 4.3 million acres in 2010 (Figure 21). Planted acreage of Kansas soybeans has trended higher at a rate of 100,245 acres per year over the 2000-2016 time period.

Harvested soybean acreage in Kansas has averaged 3.276 million acres over the 2000-2016 time period, with a low of 2.48 million acres in 2003 and an estimated high of 4.25 million acres in 2010 (Figure 21). Harvested acreage of Kansas soybeans has trended higher at a rate of 110,686 acres per year over the 2000-2016 time period.

Soybean Yields in the United States and Kansas

U.S. soybean yields are projected to average 40.16 bushels per acre over the 1990-2016 time period, with a low of 32.6 bushels per acre in 1993, and a projected high of 48.9 bushels per acre in 2016 (Figure 22). Yields of U.S. soybeans are projected to have trended higher by 0.454 bushels per acre annually over the 1990-2016 time period.

Soybean yields in Kansas are projected to have averaged 31.93 bushels per acre over the 1990-2016 time period, with a low of 20 bushels per acre in 2000, and a high of 44.5 bushels per acre in 2009 (Figure 22). Yields

of Kansas soybeans are projected to have trended higher at a rate of 0.312 bushels per acre over the 1990-2016 time period.

Soybean Production in the United States and Kansas

Soybean production in the United States is projected to average 2.856 billion bushels over the 1990-2016 time period, with a low of 1.87 billion bushels in 1993, and a forecast high of 4.06 billion bushels in 2016 (Figure 23). Production of U.S. soybeans is projected to trend higher at a rate of 62.84 million bushels per year over the 1990-2016 time period.

Soybean production in Kansas is projected to average 92.85 million bushels over the 1990-2016 time period, with a low of 43.7 million bushels in 1991, and a high of 162.4 million bushels in 2009 (Figure 23). Kansas soybean production is projected to trend higher at a rate of 3.85 million bushels per year over the 1990-2016 time period.

Soybean Total Supplies in the United States

Total supplies of soybeans in the United States have been trending higher during the 2000/01 through 2016/17 marketing years. During this 17-year period, U.S. total soybean supplies are projected to average 3.422 billion bushels, with a median or “middle” value of 3.327 billion bushels — indicating some positive skewness (i.e., a few much larger than average observations). Total supplies of U.S. soybeans are projected to have trended higher at a rate of 68 million bushels per year

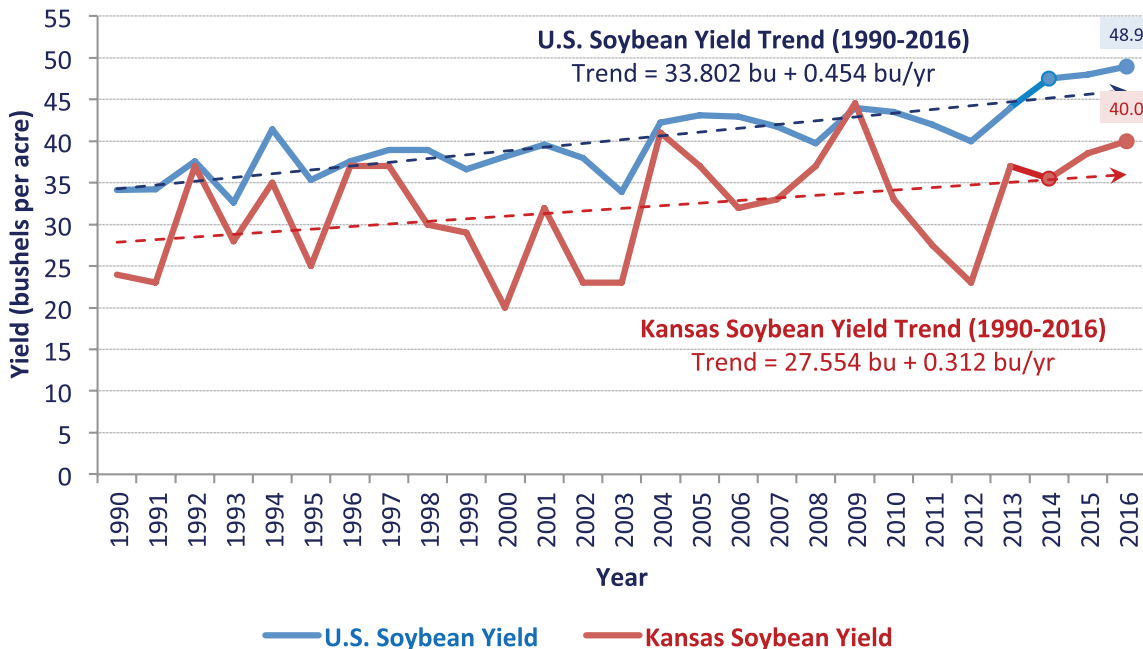

Figure 22. U.S. and Kansas Soybean Yields (1990-2016).

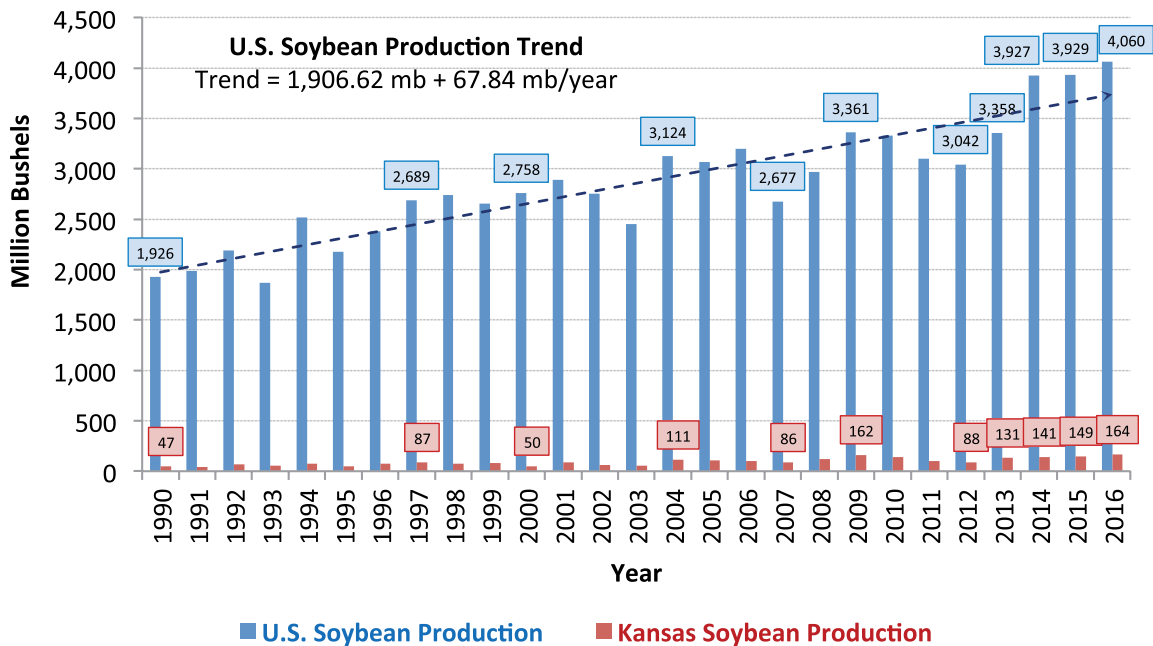

Figure 23. U.S. and Kansas Soybean Production (1990-2016).

from marketing year 2000/01 through marketing year 2016/17.

Since marketing year 2000/01, the minimum amount of U.S. soybean supplies was 2.638 billion bushels in marketing year 2003/04, while the maximum amount is projected to be 4.346 billion bushels in the 2016/17 marketing year.

Beginning stocks of U.S. soybeans are projected to average 228 million bushels since marketing year 2000/01, ranging from an estimated low of 92 million bushels in marketing year 2014/15 to a high of 574 million bushels in marketing year 2007/08. Beginning stocks are projected to trend lower over the most recent 17-year period, declining, on average, by 4 million bushels per year. Imports of U.S. soybeans are projected to average 18 million bushels since marketing year 2000/01, ranging from a low of 2 million bushels in marketing year 2001/02 to a high of 72 million bushels in marketing year 2013/14. Imports of soybeans by the United States have increased by 2 million bushels per year over the most recent 17-year period.

Soybean Usage in the United States

Total use of soybeans in the United States is projected to increase during the 2004/05 through 2016/17 marketing year time period. During this 13-year time frame, U.S. total soybean usage averaged 3.324 billion bushels, with a median value of 3.159 billion bushels. Total use of U.S. soybeans has trended higher at a rate of 85 million bushels per year over the marketing year 2004/05 through projected marketing year 2016/17 time period.

Since 2004/05, the minimum amount of U.S. soybean use was 2.878 billion bushels in marketing year 2005/06. The maximum amount of U.S. soybean total use during this period is projected to be 4.016 billion bushels in marketing year 2016/17, followed by 3.889 billion bushels in marketing year 2015/16 and 3.861 billion bushels in marketing year 2014/15.

Domestic crush of U.S. soybeans has been trending sideways to slightly higher during the 2004/05 through 2016/17 marketing year time period. During this 13-year period, U.S. total soybean domestic crush is projected to have averaged 1.765 billion bushels per marketing year, with a minimum amount of 1.648 billion bushels in marketing year 2010/11, with 1.689 billion bushels in usage in marketing year 2012/13 and 1.696 billion bushels in usage in marketing year 2004/05 being the next smallest amounts. The maximum amount of U.S. soybean domestic crush during this period is projected to be 1.940 billion bushels in marketing year 2016/17, followed closely by 1.9 billion bushels in marketing year 2015/16 and 1.873 billion bushels in marketing year 2014/15. Domestic crush usage of U.S. soybeans is projected to have trended marginally higher at a rate of 13 million bushels per year over the marketing year 2004/05 through marketing year 2016/17 time period.

Exports of U.S. soybeans have been trending higher during the 2004/05 through projected 2016/17 marketing year time period. During this 13-year period, total U.S. soybean exports are projected to average 1.430 billion bushels per marketing year, with a median amount of 1.365 billion bushels annually. The minimum amount of U.S. soybean exports during this period was

940 million bushels in marketing year 2005/06, with a projected maximum of 1.950 billion bushels in marketing year 2016/17 — followed closely by 1.880 billion bushels in marketing year 2015/16, 1.842 billion bushels in marketing year 2014/15, and 1.505 billion bushels in marketing year 2010/11. Exports of U.S. soybeans are projected to trend higher at a rate of 77 million bushels per year over the marketing year 2004/05 through marketing year 2016/17 time period.

Combined seed and residual use of U.S. soybeans has been trending marginally lower during the 2004/05 marketing year through estimated 2016/17 marketing year. During this 13-year period, U.S. soybean seed and residual use averaged 129 million bushels per marketing year. The minimum amount of U.S. soybean seed and residual use during this period was 91 million bushels in marketing year 2011/12, with a projected maximum of 199 million bushels in marketing year 2005/06 — followed by 193 million bushels in marketing year 2004/05, 157 million bushels in marketing year 2006/07, and 146 million bushels in marketing year 2014/15. Seed and residual use of U.S. soybeans is projected to trend lower at a rate of 5 million bushels per year over the marketing year 2004/05 through the projected 2016/17 marketing year.

Soybean Ending Stocks and Percent Ending Stocks-to-Use in the United States

Ending stocks of soybeans in the United States have been trending marginally lower during the 2004/05 through projected 2016/17 marketing years. During this

13-year period, U.S. soybean ending stocks averaged 247 million bushels, with a median value of 205 million bushels — indicating some relatively large ending stocks outcomes exist during this time period. Ending stocks of U.S. soybeans are projected to trend marginally lower at a rate of 12 million bushels per year over the marketing years 2004/05 through 2016/17.

Since marketing year 2004/05, the minimum amount of U.S. soybean ending stocks is estimated to be 92 million bushels in marketing year 2013/14, followed by 138 million bushels in marketing year 2008/09, 141 million bushels in marketing year 2012/13, and 151 million bushels in marketing year 2009/10. The maximum amount of U.S. soybean ending stocks during this period was 574 million bushels in marketing year 2006/07, followed by 449 million bushels in marketing year 2005/06, and 370 million bushels in marketing year 2015/16.

Percent ending stocks-to-use of soybeans in the United States also has been trending lower during the 1973/74 marketing year through the projected 2016/17 marketing year (Figure 24). During this 44-year period, U.S. soybean percent ending stocks-to-use have averaged 11.13 percent, with a median value of 10.34 percent. However, over the more recent 2006/07 through 2016/17 marketing year period, U.S. soybean percent ending stocks-to-use have declined, averaging 6.65 percent, with a median value of 5.36 percent — indicative of the impact of strong export demand for U.S. soybeans. Percent ending stocks-to-use of U.S. soybeans also has trended marginally lower at a rate of 0.52 percent per

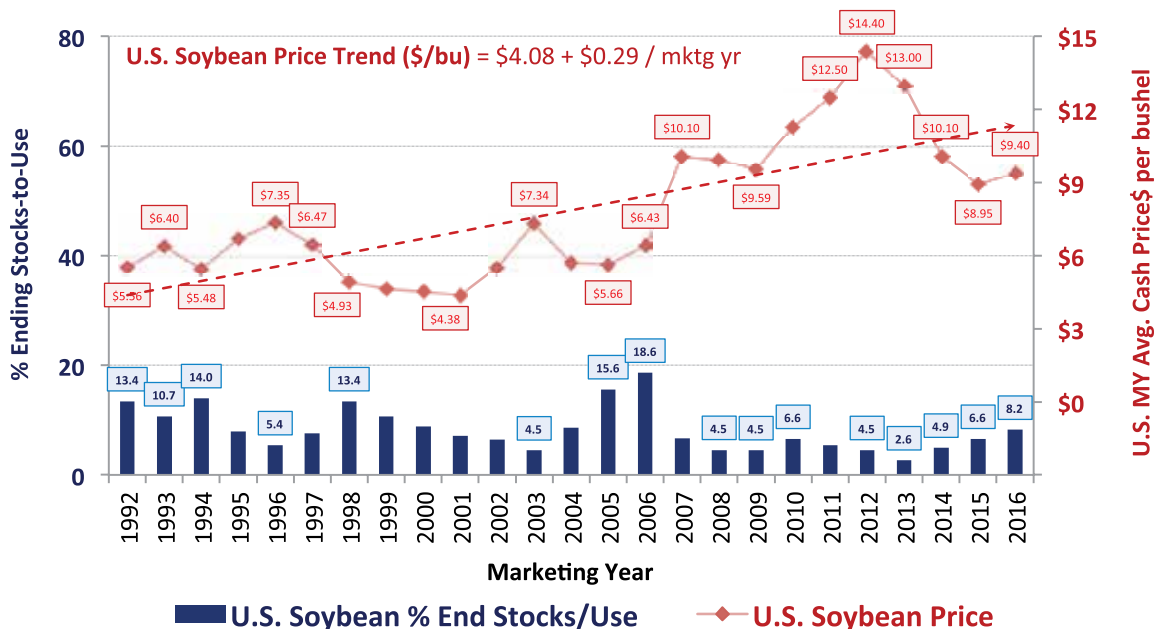

Figure 24. U.S. Percent Ending Stocks-to-Use and U.S. Average Prices (1992/1993 through 2016/2017 marketing years).

year over the marketing year 2006/07 through projected marketing year 2016/17 time period.

Since marketing year 2006/07 the minimum U.S. soybean percent ending stocks-to-use is estimated to have been 2.65 percent in marketing year 2013/14, followed by 4.49 percent in marketing year 2009/10, 4.52 percent in marketing year 2012/13, 4.54 percent in marketing year 2008/09, and marketing year 5.36 percent in marketing year 2011/12, and 6.55 percent in marketing year 2010/11. The maximum amount of U.S. soybean percent ending stocks-to-use during this period was 18.62 percent in marketing year 2006/07, followed by a projection of 8.22 percent in marketing year 2016/17, 6.56 percent in marketing year 2015/16, and 6.55 percent in marketing year 2010/11.

Soybean Season Average Prices in the United States

Since marketing year 1973/74, U.S. season average soybean prices have trended higher with an average annual increase of \$0.11 per bushel — averaging \$7.11 per bushel with a median of \$6.34 (Figure 24). During the more recent 2006/07 through 2016/17 marketing years, U.S. season average prices have averaged \$10.54 per bushel with a median of \$10.10 after starting the period with a price of \$6.43 in marketing year 2006/07. Then, after climbing to \$10.10 per bushel in marketing year 2007/08, U.S. soybean prices have ranged from a low of \$8.95 in marketing year 2015/16 to a high of \$14.40 in marketing year 2012/13, with a price forecast range of \$8.35 to \$9.85 per bushel (midpoint = \$9.10 per bushel) for marketing year 2016/17.

Soybean Profitability in Kansas

The net profitability of nonirrigated soybean production enterprises in Kansas has trended higher during the 1998 through 2015 calendar years. These net profitability estimates are based on Kansas State University Kansas Farm Management Association enterprise records, which provide information on a) annual Kansas soybean selling prices; b) revenue from all sources, including government payments, crop insurance, and crop sales; c) cost of production; d) net returns to management; and e) net returns to labor and management.

Of these key factors, both selling price and total revenues per bushel produced have trended higher over the 1998-2015 period, rising at a rate of \$0.48 and \$0.40 per bushel, respectively, for nonirrigated soybean production. Total revenues per bushel produced of soybeans have ranged from lows of \$6.00 per bushel in 2004 and \$6.21 in 1998, to highs of \$17.29 in 2012, \$14.46 in 2011, and \$13.50 in 2013. Cost of production has also trended

higher at a rate of \$0.27 per bushel per year, with lows of \$5.31 in 2004, \$6.11 in 2005, and \$6.37 in 2001, and highs of \$15.35 per bushel produced in the drought year of 2012, \$12.56 in 2011, and \$12.13 in 2000.

Net returns to management for nonirrigated soybeans in Kansas has also trended higher at a rate of \$0.27 per bushel per year, averaging \$0.62 per bushel produced during the 1998-2015 period. The low levels of net returns to management per bushel produced during this period were net losses of \$2.54 in 2000, \$1.60 in 2002, and \$1.31 per bushel in 2015. The highest levels of net returns to management per bushel produced during this period were net profits of \$2.95 in 2009, \$2.48 in 2007, \$2.44 in 2013, and \$2.32 per bushel in 2008. From 2007 forward, Kansas soybean net returns to management have averaged \$1.59 per bushel, ranging from a loss of \$1.31 to a gain of \$2.95 per bushel.

Net returns to management and labor for nonirrigated soybeans in Kansas has also trended higher at a rate of \$0.15 per bushel per year, averaging \$1.91 per bushel produced during the 1998-2015 period. The low levels of net returns to management and labor per bushel produced during this period were net losses of \$0.40 in 2000, \$0.21 in 2002, and a net profit of \$0.03 per bushel in 2015. The highest levels of net returns to management and labor per bushel produced during this period were net profits of \$3.99 in 2009, \$3.91 in 2012, \$3.79 in 2013, \$3.66 in 2007, and \$3.65 per bushel in 2010. From 2007 forward, Kansas soybean net returns to management averaged \$2.99 per bushel produced, ranging from \$0.03 to \$3.99 per bushel produced.

Net returns for irrigated soybean enterprises in Kansas were also examined during the same 1998-2015 period, with similar results. Net returns to management on a per-bushel-produced basis were higher under irrigation than with nonirrigated soybean enterprises — but net returns to management and labor were not. Consistent with this finding, although some losses occurred in irrigated Kansas soybean production enterprises over the 1998-2015 period, the losses were smaller. The worst net returns to management for irrigated soybean enterprises in Kansas from the Kansas Farm Management Association data were losses of \$0.78 per bushel produced in 2015, \$0.32 per bushel produced in 2005, \$0.26 in 2002, \$0.13 in 2004, and \$0.02 per bushel in 1998, which tended to be less than the losses that occurred in nonirrigated Kansas soybean production enterprises during this same period.

Soybean Seasonal Prices in Kansas

Kansas soybean cash prices have shown definite seasonal price patterns during the 1999/2000 through 2014/15 marketing years. Focusing on an index of Kansas

soybean price movements relative to same year's seasonal average Kansas soybean prices, prices have tended to be lowest during what is typically the Kansas soybean harvest in October. Prices trended steadily higher on a monthly basis through late fall, winter, spring, and early summer through the following July before declining in August.

The lowest price volatility around the seasonal index trend have occurred in January and March, while seasons of higher price variability have occurred during July, August, and September, that is, when the greatest uncertainty about U.S. soybean production typically exists.

International Soybean Supply/Demand

World soybean production is projected to increase at a rate of 5.3 percent or 11.6 million metric tons per year since marketing year 2007/08, and is forecast to be a record high 323.7 million metric tons in marketing year 2016/17 (Figure 25). World soybean use increased at a rate of 4.8 percent or 11.1 million metric tons annually for the same time period, and is estimated by USDA to be a record high 329.8 million metric tons in marketing year 2016/17. Following production and usage, world soybean export trade is also estimated to have increased at a rate of 84 percent or 6.6 million metric tons annually for the same time period to a projected record high 137.7 million metric tons in marketing year 2016/17. World soybean ending stocks have trended higher since marketing year 2007/08 at a rate of 2.9 percent or 1.5 million metric tons per year up. The record high of world soybean ending stocks as 78.3 million metric tons

in marketing year 2014/15, with a projection of 66.3 million metric tons in marketing year 2016/17.

World Soybean Production by Country

Over the marketing year 2014/15 period through the marketing year 2016/17 period, the United States is estimated to produce an average of 108.1 million metric tons of soybeans, compared to 98.9 million metric tons for Brazil, 58.3 million metric tons for Argentina, 12.0 million metric tons for China, 8.8 million metric tons for Paraguay, and 34.9 million metric tons for other countries. Major factors in world soybean production include a) the predominant roles that the United States, Brazil, and Argentina play in world soybean production, b) the limited production of soybeans in China relative to their soybean usage, c) prospects for long-term growth in Indian, Ukrainian, and Canadian soybean crop size, and d) the growing world position of other South American countries besides Argentina and Brazil (e.g., Paraguay) in world soybean production.

World Soybean Exports by Country

In the 2014/15 marketing year through the 2016/17 marketing year time period, the United States is estimated to have exported an average of 51.5 million metric tons of soybeans, compared to 55.6 million metric tons for Brazil, 10.6 million metric tons for Argentina, 4.75 million metric tons for Paraguay, and 10.1 million metric tons for other countries. In world soybean export markets, the United States, Brazil, Argentina, and other South American countries such as Paraguay play predominant roles. Long-term growth has occurred in Canada

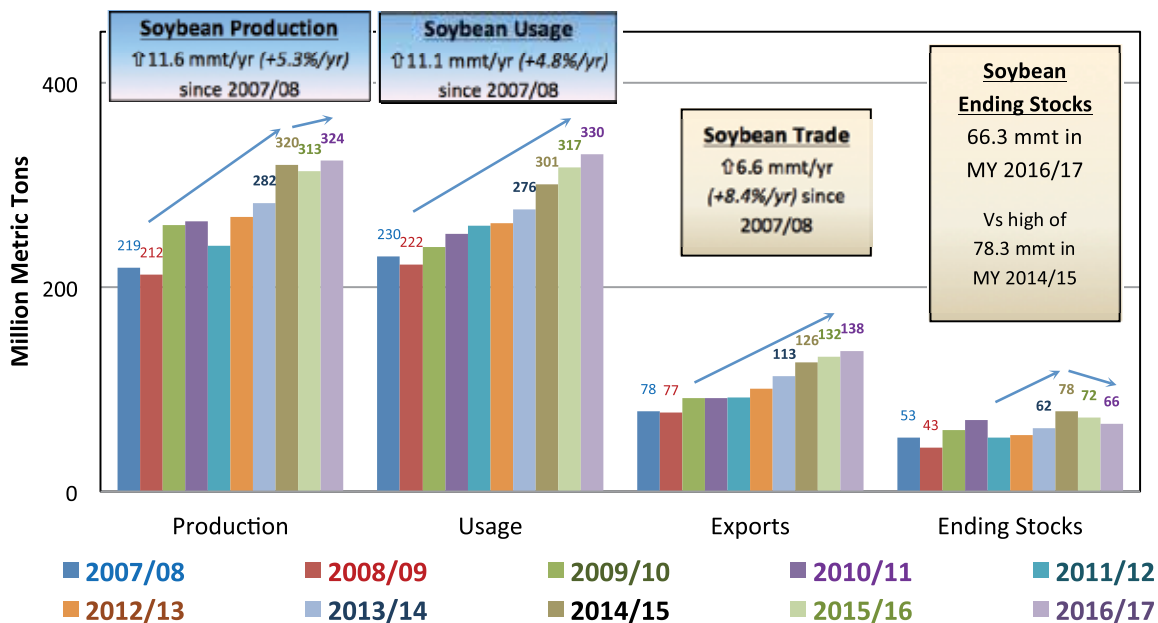

Figure 25. World Soybean Usage and Ending Stocks: MY 2007/08 through MY 2016/17 — (August 12, 2016 USDA WASDE Report).

and Ukraine soybean exports — although they are still limited in scale. Argentina processes a large proportion of its soybean production and sells these coproducts on world markets in the form of soybean meal and oil, and is the predominant world exporter of both of these soybean coproducts.

World Soybean Imports by Country

From marketing year 2014/15 through marketing year 2016/17, China is projected to have imported an average of 82.8 million metric tons of soybeans (64 percent of total world soybean imports), compared to 13.3 million metric tons from the European Union (10 percent of the world total), 3.9 million metric tons for Mexico, 3.1 million metric tons for Japan, and 46.5 million metric tons for other countries. These numbers indicate a) the dominant position of China as a world soybean importer, and b) the important, but secondary, position of the European Union and all other countries in the world soybean import market.

Chinese imports of soybeans have grown on average by 5.8 million metric tons per year since marketing year 2006/07 when Chinese imports totaled 28.7 million metric tons. In marketing year 2016/17, Chinese soybean imports are estimated to total 87.0 million metric tons.

World Soybean Usage by Type and Region of the World

From marketing year 2014/15 through marketing year 2016/17, world soybean crush accounted for an average of 277.3 million metric tons of soybean use (87.8 percent of total world soybean use), compared to 38.7 million metric tons of total direct food, feed, and residual consumption usage. World soybean crush is estimated to be 300.9 million metric tons in marketing year 2016/17, compared to 37.6 million metric tons of food, seed, and residual use. World domestic crush has grown somewhat steadily larger over time and is predominant over the important but secondary position of direct food and feed waste use in world soybean usage.

Over the marketing year 2014/15 through marketing year 2016/17 period, China is estimated to be the largest major user of soybeans in the world, averaging of 94.6 million metric tons of soybeans per marketing year (30 percent of total world soybean use). China is closely followed by:

a. the United States — averaging 55.3 million metric tons per year,

- b. Argentina — averaging 47.2 million metric tons per year,
- c. Brazil — averaging 43.6 million metric tons per year,
- d. the European Union — averaging 15.35 million metric tons per year,
- e. Mexico — averaging 4.3 million metric tons per year,
- f. Paraguay — averaging 4.0 million metric tons annually,
- g. Japan — averaging 3.4 million metric tons annually, and
- h. other countries — averaging 46.5 million metric tons per year.

Major world soybean use trends include a) the growth and dominance of East Asia-China, South America, and North America as soybean using regions, and b) the important secondary positions of the European Union and other countries in terms of world soybean usage.

World Soybean Ending Stocks and Percent Ending Stocks-to-Use

World soybean ending stocks have increased by 1.5 million metric tons per year since marketing year 2007/08, while world soybean percent ending stocks-to-use have decreased by 0.31 percent per marketing year. World soybean ending stocks are estimated to have been a record high 78.3 million metric tons in marketing year 2014/15, compared to the previous high of 70.6 million metric tons in marketing year 2011/12 — but are projected to have declined to 66.3 million metric tons in marketing year 2016/17. Similarly, world soybean ending stocks-to-use are estimated to have been at 26 percent in marketing year 2014/15, compared to the previous highs of 25.2 percent in marketing year 2006/07, and 27.8 percent in marketing year 2010/11. World soybean ending stocks-to-us are projected to have declined to 22.8 percent in marketing year 2015/16 and to a 9-year low of 19.4 percent in marketing year 2016/17.

The apparent strategy on the part of world soybean producing and using countries since the 1992/93 marketing year has been to hold increased amounts of world stocks. China and Argentina in particular have been holders of soybean stocks — but for different reasons. China's interest is in food security, while Argentina crop producers holds stocks to support soybean processing on the one hand and as a “commodity value” hedge against problematic domestic inflationary pressures on the other.

Harvesting Soybeans

Field studies in soybeans have shown that 4-bushel-per-acre machine losses are not uncommon. Field experiences and research studies show machine losses of soybeans can be reduced to less than 1 bushel per acre. The results of a 1989 study conducted at The Ohio State University found the average machine loss in soybeans was 1.4 bushels per acre, but the highest loss was 4.1 bushels per acre. About 40 percent of the operators studied had losses less than 1 bushel per acre, while almost 20 percent had losses exceeding 2 bushels per acre. To reduce losses, combine operators need to know where harvesting losses occur, how to measure losses, what reasonable levels of loss are, and the equipment adjustments and operating practices that help reduce losses.

Where Losses Occur

Soybean losses can occur before harvest as preharvest loss or during harvest as machine loss. Preharvest loss can be high, and it can only be minimized by harvesting in a timely fashion. Machine loss can occur at several places in the combine, but the most common for soybeans is at the header. Cleaning and separating losses are generally minimal compared to gathering loss. Soybeans are fragile and shatter easily, so close attention should be paid to header adjustments and operation.

Measuring Harvest Losses

It is necessary to have a means to enclose an area of 10 square feet that is representative of the entire swath width. For narrow platforms or heads, this is probably most easily done by using a continuous strip across the full cutting width of the machine. For large platforms, it may be easier and more suitable to count only in selected areas, such as every other row, across the width of the machine. In any case, the important part is obtaining a representative sample. Rigid frames can be made from heavy wire or wood or metal rod. Flexible frames can

be made from plastic clothesline and wire stakes in the corners (Table 11).

Loss Measurement Procedure

This procedure is designed to minimize the time and effort required to check harvesting losses (Figure 26). Ground counts are taken only as required.

- Determine total loss:** Operate combine under typical operating and field conditions. Stop the combine and back up about 20 feet. In the harvested area behind the combine, count the beans in a 10 square foot area across the entire swath width and enter this count in the loss data table. Divide this number by 40 and enter the loss in bushels per acre. If the total loss is less than 3 percent of yield, keep harvesting. If loss is greater than 3 percent, continue this procedure to pinpoint the source of loss.
- Determine preharvest loss:** In the unharvested area in front of the combine, count loose beans on the ground and beans in pods lying loose on the ground in a 10-square-foot area across the entire width of cut. Enter this count and then divide by 40 to get loss in bushels per acre.
- Determine machine loss:** Machine loss is calculated by subtracting the preharvest loss from the total crop loss. If machine loss is less than 3 percent of yield, keep harvesting. If machine loss is more than 3 percent, proceed to check gathering unit losses.
- Determine header loss:** In a 10-square-foot area across the entire width of cut in front of the combine, count and categorize beans according to the type of loss below. Header loss is the sum of these four losses.
 - Shatter loss:* Loose beans on the ground and beans in loose pods on the ground minus the preharvest loss count.
 - Loose stalk loss:* All beans in pods attached to stalks that were cut but not gathered into the machine.

Table 11. *Examples of frames and usage.*

Less than 20-foot harvest width:	sample area is entire swath width by a distance that can be calculated as: $120 / \text{swath width in feet} = \text{sample distance in inches}$, e.g. a 15-foot platform would have a sample area the width of the header and $(120 / 15) = 8$ inches long
25-foot swath width:	4.8-inch by 30-inch frame used 10 times across the entire width of the cut (every row in 30-inch rows)
30-foot swath width:	4-inch by 30-inch frame used 12 times across the entire width of the cut (every row in 30-inch rows)
36-foot swath width:	4-inch by 30-inch rigid frame used 12 times spaced evenly across the width of cut – or- A rope frame measuring $3\frac{1}{3}$ inches across the entire width of the cut

Lodged stalk loss: All beans in pods attached to soybean stalks that were lodged and are still attached to the ground.

Stubble loss: All beans in pods still attached to stubble.

- Determine cylinder and separation loss:** Subtract the gathering unit loss from the machine loss.

Compare harvest loss levels to goal loss levels.

Concentrate on machine adjustments and operating practices that will give the least total loss.

Gathering Equipment

Several machinery developments have improved gathering efficiency over that of a conventional cutter-bar platform in soybeans. Some of these are the add-on flexible-floating cutter bar, the integral flexible-floating cutter bar, the row crop head, narrow pitch cutter bar, and flex-draper headers. Stripper headers are not recommended for harvesting soybeans.

Tests in Illinois in 30-inch rows showed header losses averaged 8.7 percent of the total yield with an add-on, flexible-floating cutter bar, 3.8 percent with an integral flexible-floating cutter bar, and 1.4 percent with a row-crop head. These tests indicate an advantage of the integral flexible-floating cutter bar over the add-on. The row crop head seems to have a clear advantage over both cutter bar arrangements in these tests.

Tests in Louisiana compared an integral flexible-floating cutter bar to a row-crop head in 40-inch rows. The average harvest losses were 3.4 percent with the integral flexible-floating cutter bar and 3.0 percent with the row crop head. Additionally, tests were run with the integral flexible-floating cutter bar in 7-inch rows and 30-inch rows to determine the effect of row width on harvest losses. The average losses were 1.4 percent in

7-inch rows, 2.2 percent in 30-inch rows, and 3.4 percent in the 40-inch rows as previously stated. These tests did not show the clear advantage of the row-crop head over the integral flexible-floating cutter bar that the Illinois tests did in a direct comparison. If the narrow rows are considered, it appears harvest losses would be lower with the integral flexible-floating cutter bar.

Other tests have shown narrow-pitch (1.5-inch) cutter bars typically have about two-thirds of the gathering losses that occur with the standard 3-inch-pitch cutter bars. Narrow pitch sections and guards can be ordered as optional equipment on some models or obtained from after-market companies.

The data given here should indicate representative losses with various gathering units in standing crop conditions. An important factor not addressed is harvesting under adverse conditions, mainly lodging. Tests have not been done in soybeans to determine losses with different gathering units under various degrees of lodging.

Although specialized gathering equipment for soybeans can significantly reduce harvesting losses, there is the cost factor to consider to make sure the equipment is economically justifiable. Some key factors in this decision are acreage farmed, present machinery, and other crops that a header can be used for. The flexible-floating cutter bar and flex-drapers work well in wheat, grain sorghum, and soybeans. Row-crop heads work exceptionally well in row-planted grain sorghum and soybeans. A comparison can be made to see if the improved gathering efficiency would justify an additional investment in some of the specialized gathering equipment for soybean harvesting.

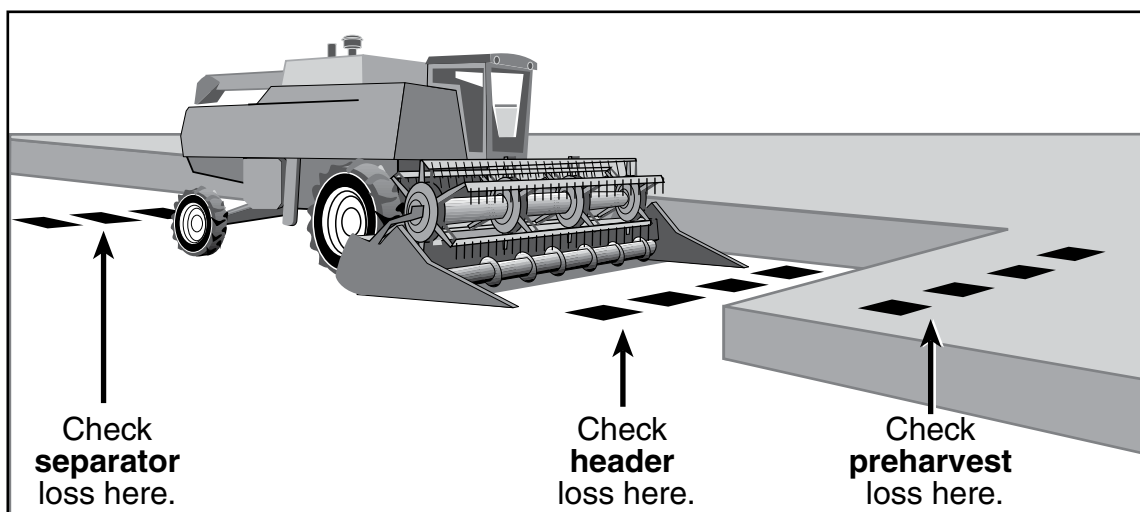

Figure 26. *Measuring soybean harvest losses.*

Combine Adjustment and Operation

Reel speed and position are extremely important in harvesting soybeans. The reel should be positioned for minimum disturbance of standing plants. Reels with pickup fingers cause the least disturbance to the standing plants. When the reel is positioned properly, the soybean plants will be conveyed smoothly across the cutter bar, along the auger or draper belt, and into the combine feederhouse.

Gathering losses are minimized when the reel speed is set to 150 percent of ground speed at low ground speeds and adjusted downward to 125 percent as ground speeds are increased. A 42-inch reel should rotate at about 10 to 12 rpm for each 1 mph of ground speed to equate to speeds of 125 percent to 150 percent of ground speed. The reel will shatter beans excessively if it turns too fast, and too many stalks may be dropped or recut if it turns too slowly. Position the reel 8 to 12 inches ahead of the sickle. A bat reel should be operated just low enough to tip the stalks onto the platform.

Ground speed can have a significant effect on harvest losses and seed damage. At the header, travel speed has been reported to influence gathering loss more than any other factor. Less than optimum ground speeds increase header loss through increased shattering, ground speeds in excess of cutter bar capacity result in poor cutting action and stripping of pods. Seed damage in the threshing process is typically higher at low ground speeds, especially in headlands. At low ground speeds there is less material other than grain passing through the threshing system, which can act as a cushion in preventing damage to the grain.

Before the combine goes to the field, there are a number of other adjustments that should be made using the operator's manual as a guide. These include cylinder or rotor speed, cylinder-concave clearance, sieve settings, and fan adjustment. The operator's manual provides a good starting point for settings under typical conditions. Operators need to make additional minor adjustments to accommodate changing conditions, oftentimes within the day.

Seed damage is affected more by cylinder/rotor speed than by concave clearance, especially at grain moisture contents below 12 percent. It is important to adjust the cylinder/rotor speed as conditions change throughout the day and the harvest season. The lowest cylinder/rotor speed that removes soybeans from their pods should be used to minimize seed damage and foreign material in the grain sample. Tests have been conducted to compare seed quality with rotary and conventional threshing combines. Percentage of splits with the rotary machines was typically half or less than of the splits with conventional machines. However, both types of machines have the capability to harvest with less than the 10-percent limit of splits for U.S. No. 1 soybeans and both have the potential to cause significant seed damage when operated at speeds exceeding what is necessary for complete threshing.

If weedy conditions are encountered during harvest, especially when weeds are green, reduce travel speed to maintain low threshing and separating losses. Do not increase cylinder speed, this causes excessive damage to the grain and results in more foreign material in the grain sample.

Brand names appearing in this publication are for product identification purposes only. No endorsement is intended, nor is criticism implied of similar products not mentioned.

Publications from Kansas State University are available at: www.ksre.ksu.edu

Publications are reviewed or revised annually by appropriate faculty to reflect current research and practice. Date shown is that of publication or last revision. Contents of this publication may be freely reproduced for educational purposes.

All other rights reserved. In each case, credit *Soybean Production Handbook*, Kansas State University, October 2016.